

AIRPORT DIAGRAM

HECTOR INTL (F.A.R.)
FARGO, NORTH DAKOTA

AL-144 (FAA)

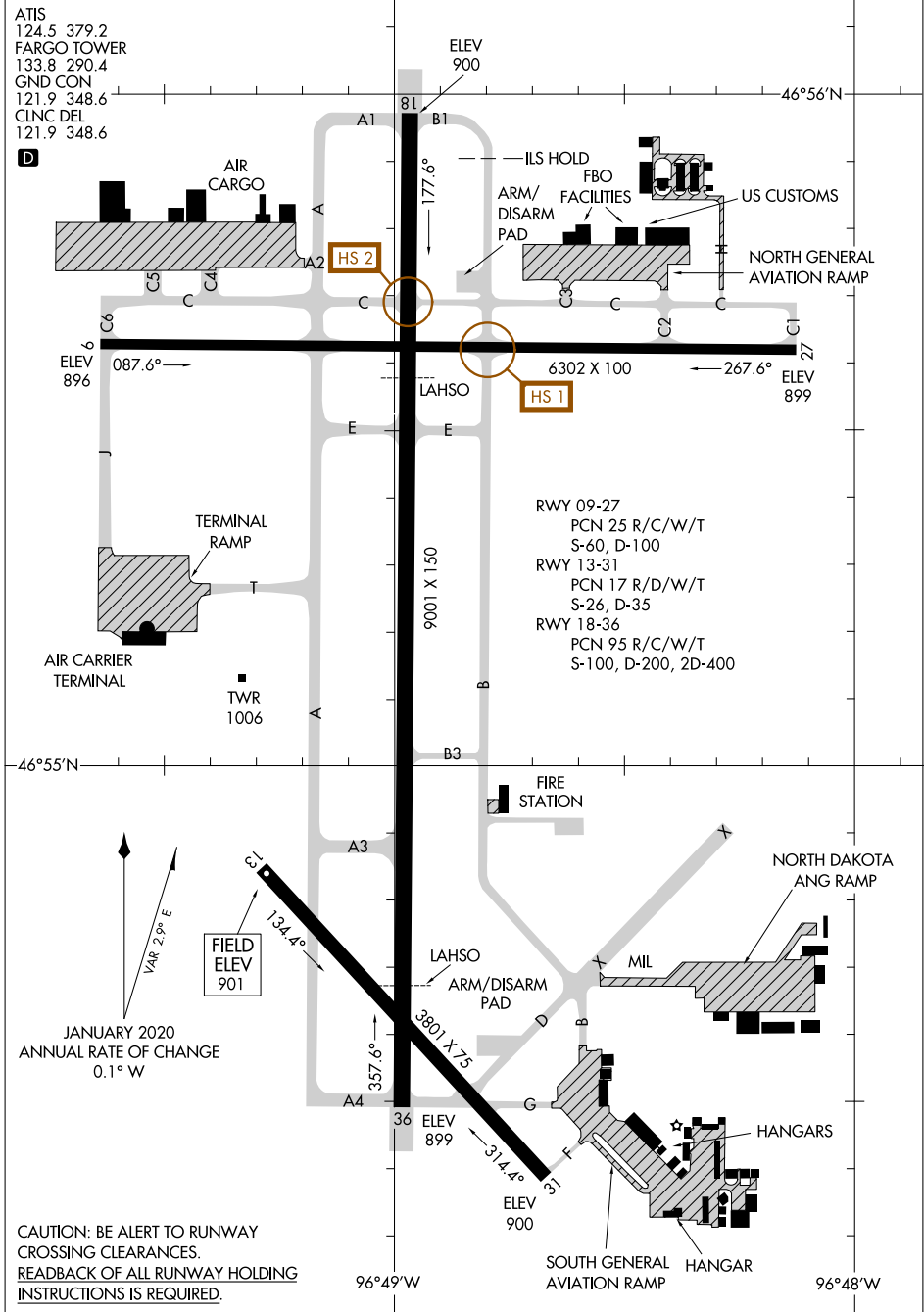

NC-1, 22 FEB 2024 to 21 MAR 2024

NC-1, 22 FEB 2024 to 21 MAR 2024

HOT SPOTS

An "airport surface hot spot" is a location on an aerodrome movement area with a history or potential risk of collision or runway incursion, and where heightened attention by pilots/drivers is necessary.

A "hot spot" is a runway safety related problem area on an airport that presents increased risk during surface operations. Typically it is a complex or confusing taxiway/taxiway or taxiway/runway intersection. The area of increased risk has either a history of or potential for runway incursions or surface incidents, due to a variety of causes, such as but not limited to: airport layout, traffic flow, airport marking, signage and lighting, situational awareness, and training. Hot spots are depicted on airport diagrams as open circles or polygons designated as "HS 1", "HS 2", etc. and tabulated in the list below with a brief description of each hot spot. Hot spots will remain charted on airport diagrams until such time the increased risk has been reduced or eliminated.

CITY/AIRPORT	HOT SPOT	DESCRIPTION*
DULUTH, MN DULUTH INTL (DLH)	HS 1	Rwy 21 via Twy A and Twy C complex int.
FARGO, ND HECTOR INTL (FAR)	HS 1 HS 2	Rwy 09-27 at Twy B. Rwy 18-36 at Twy C.
GRAND FORKS, ND GRAND FORKS INTL (GFK)	HS 1 HS 2	Rwy 09L and Twy A int. Rwy 17R and Twy B int.
MINNEAPOLIS, MN CRYSTAL (MIC)	HS 1 HS 2	Int of Rwy 06R (sod) on Twy F. Int of Rwy 24L (sod) on Twy D.
MINNEAPOLIS, MN FLYING CLOUD (FCM)	HS 1 HS 2	Rwy 18 apch area along Twy A. Short taxi distance from ramp to rwy hold line.
MINNEAPOLIS, MN MINNEAPOLIS-ST PAUL INTL/ WOLD-CHAMBERLAIN (MSP)	HS 1 HS 2 HS 3	Twy A, Twy B, Twy C, Twy D, Twy H, Rwy 04-22 and Rwy 12R-30L, complex geometry. Complex geometry at the int of Twy C, Twy P8, Twy D, Twy P, Twy Q, and the Rwy 04-22 and Rwy 12L-30R int, rqr caution for Rwy crossings in this area. Twy/rwy geometry and traffic flow.
MINOT, ND MINOT INTL (MOT)	HS 1 HS 2	Apch end of Rwy 08. Int of Twy C and Rwy 08-26.
ROCHESTER, MN ROCHESTER INTL (RST)	HS 1	Complex int; Twy A6, Rwy 13-31, Rwy 03-21 and Twy B.
ST. PAUL, MN ST. PAUL DOWNTOWN HOLMAN FLD (STP)	HS 1 HS 2 HS 3	Helicopter landings on Twy A. Twy D between Rwy 13 and Rwy 32 unusual configuration for rwy holding position markings. Helicopter operations on Twy B.

*See appropriate Chart Supplement HOT SPOT table for additional information.

LOC I-AAM 108.9	APP CRS 176°	Rwy Idg 9001	TDZE 900	Apt Elev 901
---------------------------	------------------------	-----------------	-------------	-----------------

ILS or LOC RWY 18

HECTOR INTL (FAR)

ADF or DME required for procedure entry.		MALSRS 	MISSED APPROACH: Climb to 2500 direct FAR VOR/DME and hold.
<p></p> <p>For inop MALSRS, increase S-ILS 18 Cat E visibility to RVR 4000, and S-LOC 18 Cat E visibility to RVR 5000.</p> <p>* Visibility Cat A/B/C/D RVR 1800 authorized with the use of FD or AP or HUD to DA.</p>			

ATIS 124.5 379.2	FARGO APP CON 120.4 377.15	FARGO TOWER 133.8 290.4	GND CON 121.9 348.6	CLNC DEL 121.9 348.6
----------------------------	--------------------------------------	-----------------------------------	-------------------------------	--------------------------------

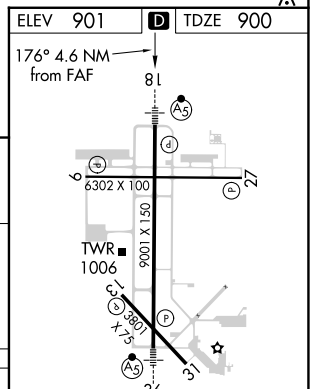
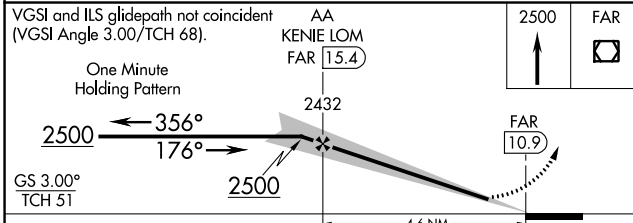
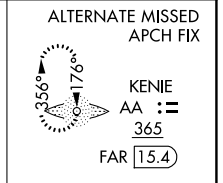
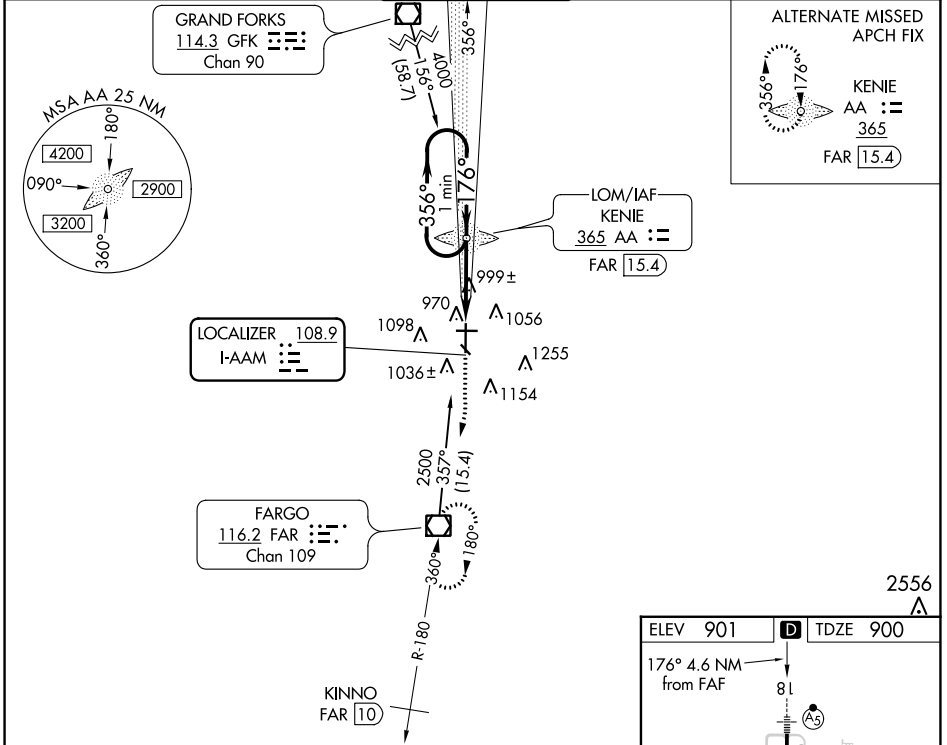

CATEGORY	A	B	C	D	E	HIRL Rwy 18-36 REIL Rwys 9 and 27 MRL Rwys 9-27 and 13-31 FAF to MAP 4.6 NM
S-ILS 18*	1100/24 200 (200-1/2)					
S-LOC 18	1260/24	360 (400-1/2)	1260/40	360 (400-3/4)		
CIRCLING	1380-1	479 (500-1)	1520-1 3/4 619 (700-1 3/4)	1620-2 1/4 719 (800-2 1/4)	1620-2 1/2 719 (800-2 1/2)	
	Knots	60	90	120	150	180
	Min:Sec	4:36	3:04	2:18	1:50	1:32

NC-1, 22 FEB 2024 to 21 MAR 2024

NC-1, 22 FEB 2024 to 21 MAR 2024

LOC/DME I-FAR 110.3 Chan 40	APP CRS 356°	Rwy Idg TDZE Apt Elev	9001 899 901
---	------------------------	-----------------------------	---

ILS or LOC RWY 36

HECTOR INTL (F.A.R.)

ADF or DME required for procedure entry. ADF or DME required.

MAJRS 

MISSED APPROACH: Climb to 2500 direct KENIE LOM and hold (DME aircraft climb to 4000 on FAR VOR/DME R-358 to GORGY/22 DME and hold N, RT, 178° inbound, continue climb-in-hold to 4000).

ATIS 124.5 379.2	FARGO APP CON 120.4 377.15	FARGO TOWER 133.8 290.4	GND CON 121.9 348.6	CINC DEL 121.9 348.6
----------------------------	--------------------------------------	-----------------------------------	-------------------------------	--------------------------------

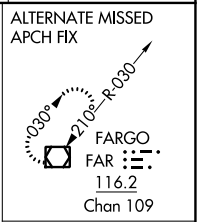
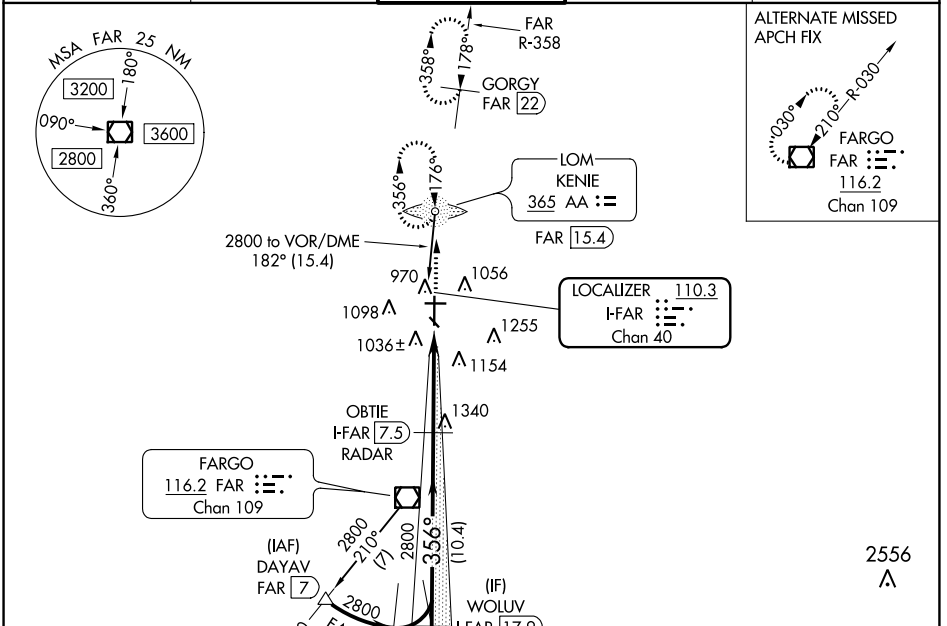

ELEV 901	TDZE 899
----------	----------

MIRL Rwy 9-27 and 13-31
REIL Rwy 9 and 27
HIRL Rwy 18-36 81

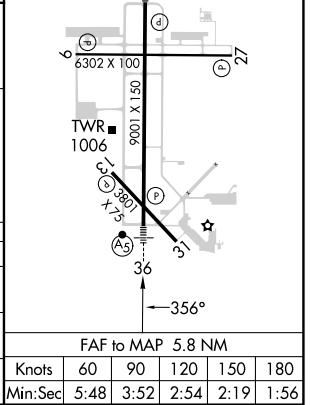
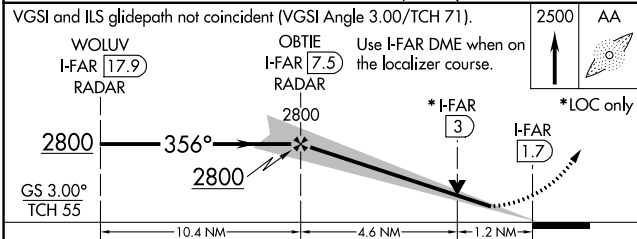

CATEGORY	A	B	C	D	E	
S-ILS 36#	1099/24 200 (200-½)					
S-LOC 36	1360/24	461 (500-½)	1360/50 461 (500-1)			
CIRCLING	1380-1	479 (500-1)	1520-1¾ 619 (700-1¾)	1620-2¼ 719 (800-2¼)	1620-2½ 719 (800-2½)	
	Knots	60	90	120	150	180
	Min:Sec	5:48	3:52	2:54	2:19	1:56

NC-1, 22 FEB 2024 to 21 MAR 2024

NC-1, 22 FEB 2024 to 21 MAR 2024

WAAS CH 40006 W18A	APP CRS 176°	Rwy Idg TDZE Apt Elev	9001 900 901
--	------------------------	-----------------------------	---

RNAV (GPS) RWY 18

HECTOR INTL (F.A.R.)

RNP APCH.

⚠ For inoperative MALS/R, increase LPV Cat E visibility to RVR 4000 and LNAV/VNAV Cat E and LNAV Cat D and E to RVR 6000. For uncompensated Baro-VNAV systems, LNAV/VNAV NA below -16°C (4°F) or above 47°C (116°F). #RVR 1800 authorized with use of FD or AP or HUD to DA.

MALS/R 

MISSED APPROACH: Climb to 3500 direct KOBME and hold.

ATIS 124.5 379.2	FARGO APP CON 120.4 377.15	FARGO TOWER 133.8 290.4	GND CON 121.9 348.6	CLNC DEL 121.9 348.6
----------------------------	--------------------------------------	-----------------------------------	-------------------------------	--------------------------------

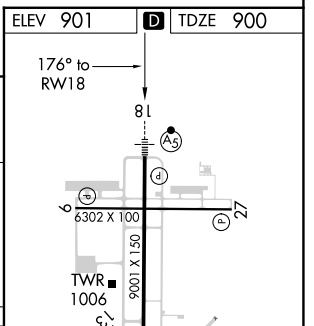
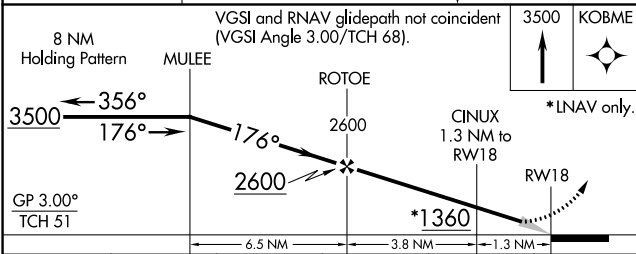
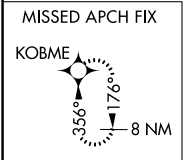
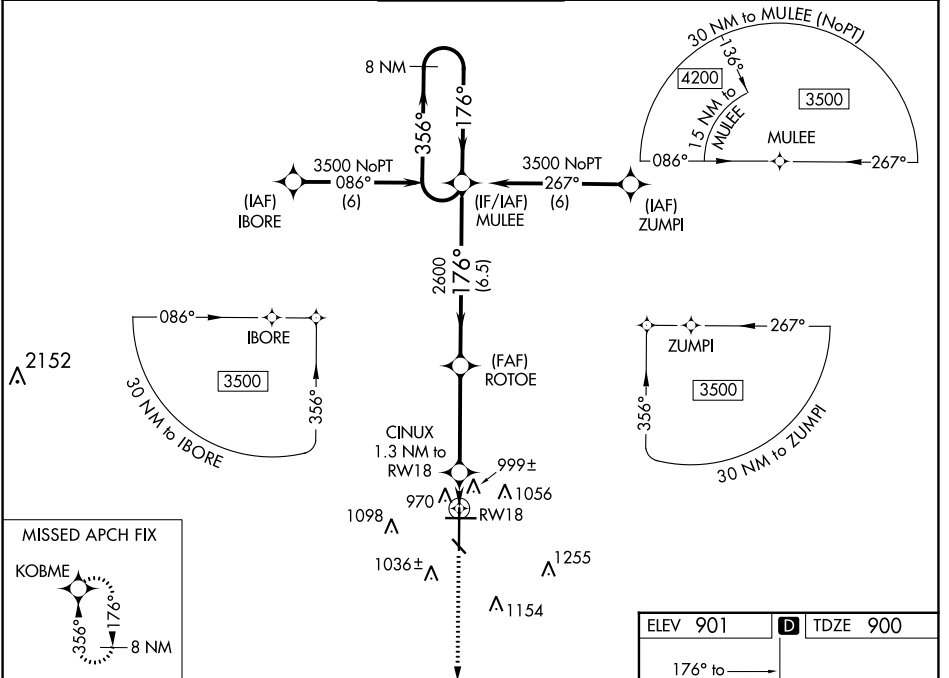

CATEGORY	A	B	C	D	E
LPV DA#	1100/24		200 (200-½)		
LNAV/VNAV DA	1272/40		372 (400-¾)		
LNAV MDA	1260/24 360 (400-½)		1260/50 360 (400-1)		
C CIRCLING	1380-1 479 (500-1)	1520-1¾ 619 (700-1¾)	1620-2¼ 719 (800-2¼)	1620-2½ 719 (700-2½)	

HIRL Rwy 18-36
REIL Rwys 9 and 27
MIRL Rwys 9-27 and 13-31

NC-1, 22 FEB 2024 to 21 MAR 2024

NC-1, 22 FEB 2024 to 21 MAR 2024

WAAS CH 65733 W27A	APP CRS 267°	Rwy ldg 6302 TDZE 899 Apt Elev 901
--	------------------------	---

RNAV (GPS) RWY 27

HECTOR INTL (F.A.R.)

RNP APCH.		MISSED APPROACH: Climb to 3500 direct IDVIY and hold.		
Baro-VNAV NA. Rwy 27 helicopter visibility reduction below 3/4 SM NA.				

ATIS 124.5 379.2	FARGO APP CON 120.4 377.15	FARGO TOWER 133.8 290.4	GND CON 121.9 348.6	CLNC DEL 121.9 348.6
----------------------------	--------------------------------------	-----------------------------------	-------------------------------	--------------------------------

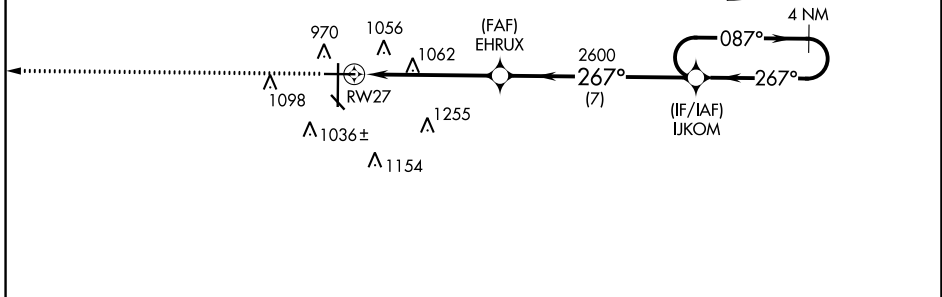
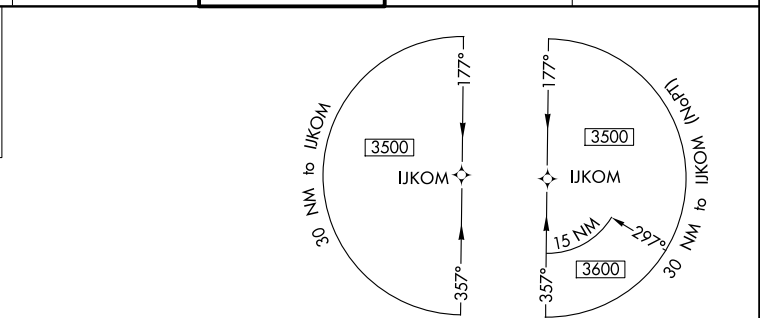
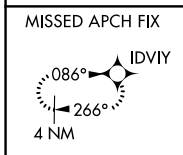

ELEV 901	D	TDZE 899
----------	----------	----------

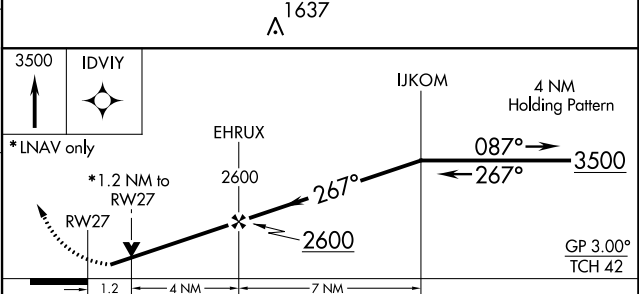
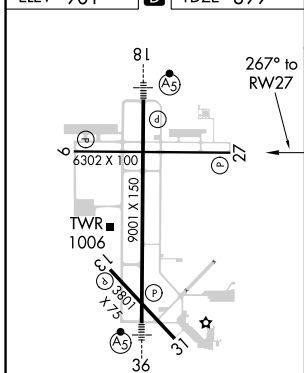

CATEGORY	A	B	C	D
LPV DA		1149-3/4	250 (300-3/4)	
LNAV/VNAV DA		1231-1/8	332 (400-1/8)	
LNAV MDA	1320-1	421 (500-1)	1320-1 1/4	421 (500-1 1/4)
C CIRCLING	1380-1	479 (500-1)	1520-1 3/4	1620-2 1/4
			619 (700-1 3/4)	719 (800-2 1/4)

HIRL Rwy 18-36
REIL Rwy 9 and 27
MIRL Rwy 9-27 and 13-31

WAAS CH 50106 W36A	APP CRS 356°	Rwy Idg TDZE Apt Elev	9001 899 901
--	------------------------	-----------------------------	---

RNAV (GPS) RWY 36

HECTOR INTL (F.A.R.)

RNP APCH. Baro-VNAV NA below -16°C (4°F). For inop MALSR, increase LPV Cat E visibility to RVR 4000, and increase LNAV/VNAV and LNAV Cat E visibility to 1½ mile.	MALSR 	MISSED APPROACH: Climb to 3500 direct MULEE and hold.
--	-----------	---

ATIS 124.5 379.2	FARGO APP CON 120.4 377.15	FARGO TOWER 133.8 290.4	GND CON 121.9 348.6	CLNC DEL 121.9 348.6
----------------------------	--------------------------------------	--	-------------------------------	--------------------------------

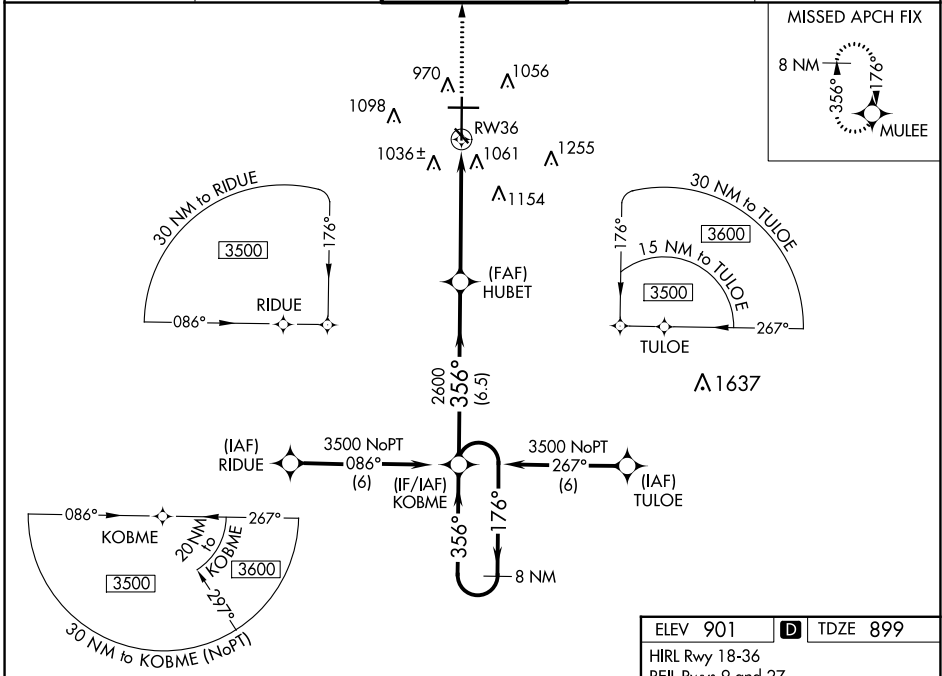

NC-1, 22 FEB 2024 to 21 MAR 2024

NC-1, 22 FEB 2024 to 21 MAR 2024

VGSIs and RNAV glidepath not coincident (VGSi Angle 3.00/TCH 71). 8 NM Holding Pattern KOBME HUBET MULEE *1.4 NM to RW36 *LNAV only. RW36 GP 3.00° TCH 55 3500 176° 356° 356° 2600 6.5 NM 3.7 NM 1.4					
CATEGORY	A	B	C	D	E
LPV DA	1150/24 251 (300-½)				
LNAV/VNAV DA	1360/50 461 (500-1)			1360/60 461 (500-1¼)	
LNAV MDA	1420/24 521 (600-½)	1420/50 521 (600-1)	1420/60 521 (600-1¼)		
CIRCLING	1420-1 519 (600-1)	1520-1¾ 619 (700-1¾)	1620-2¼ 719 (800-2¼)	1620-2½ 719 (800-2½)	

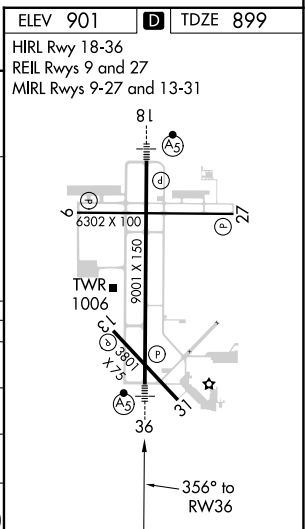

WAAS CH 97433 W09A	APP CRS 086°	Rwy Idg TDZE Apt Elev	6302 900 901
--	------------------------	-----------------------------	---

RNAV (GPS) RWY 9

HECTOR INTL (F.A.R.)

RNP APCH.		MISSED APPROACH: Climb to 3500 direct IJKOM and hold.		
Baro-VNAV NA. Rwy 9 helicopter visibility reduction below 3/4 SM NA.				
ATIS 124.5 379.2	FARGO APP CON 120.4 377.15	FARGO TOWER 133.8 290.4	GND CON 121.9 348.6	CLNC DEL 121.9 348.6

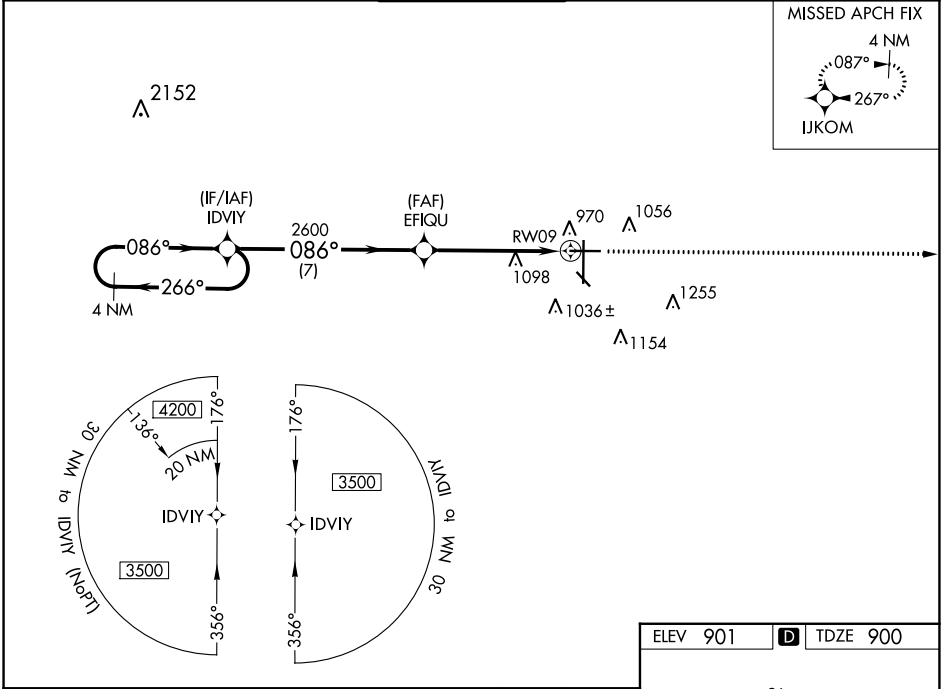

NC-1, 22 FEB 2024 to 21 MAR 2024

NC-1, 22 FEB 2024 to 21 MAR 2024

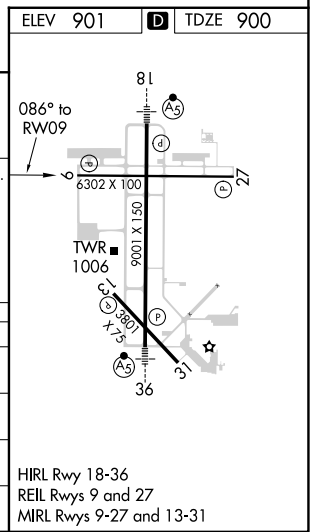
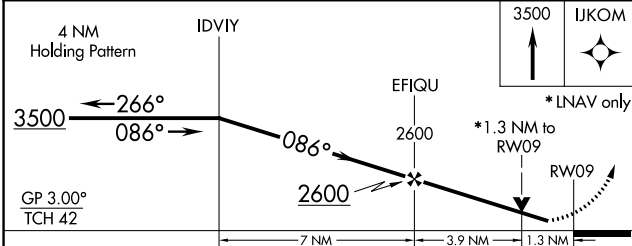

CATEGORY	A	B	C	D
LPV DA		1150-3/4	250 (300-3/4)	
LNAV/VNAV DA		1171-7/8	271 (300-7/8)	
LNAV MDA	1360-1	460 (500-1)	1360-1 3/8	460 (500-1 3/8)
CIRCLING	1380-1	479 (500-1)	1520-1 3/4	1620-2 1/4
			619 (700-1 3/4)	719 (800-2 1/4)

VOR/DME FAR 116.2 Chan 109	APP CRS 360°	Rwy Idg TDZE 899 Apt Elev 901
--	------------------------	---

VOR RWY 36

HECTOR INTL (FAR)

For inop MALSRS, increase S-36 Cat E visibility to 2½ miles. STABS Fix Minimums: For inop MALSRS, increase S-36 Cat E visibility to 1¾ mile.		MISSED APPROACH: Climbing left turn to 3500 direct FAR VOR/DME and hold.

ATIS 124.5 379.2	FARGO APP CON 120.4 377.15	FARGO TOWER 133.8 290.4	GND CON 121.9 348.6	CINC DEL 121.9 348.6
----------------------------	--------------------------------------	--	-------------------------------	--------------------------------

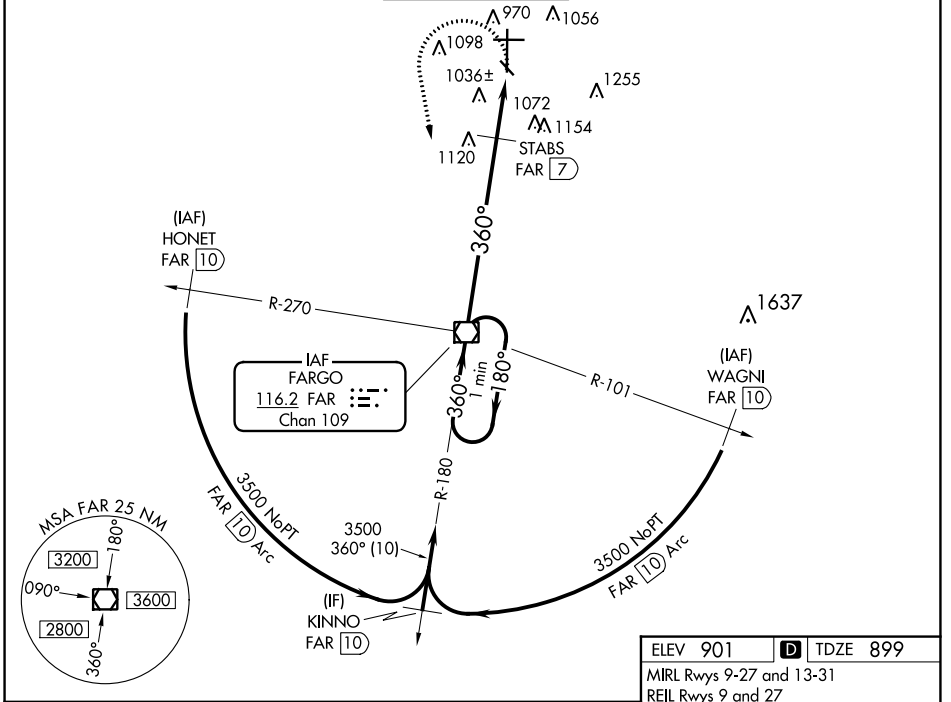

NC-1, 22 FEB 2024 to 21 MAR 2024

NC-1, 22 FEB 2024 to 21 MAR 2024

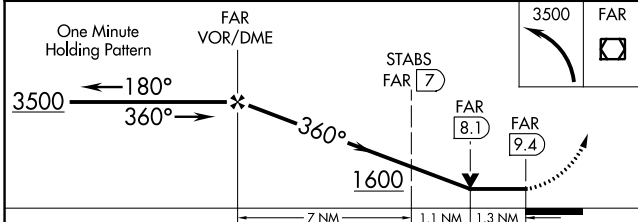
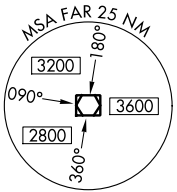

ELEV 901	TDZE 899
MRL Rwy 9-27 and 13-31 REIL Rwy 9 and 27 HIRL Rwy 18-36 81	
TWR 1006 360° 9.4 NM from FAF FAF to MAP 9.4 NM	
Knots	60 90 120 150 180
Min:Sec	9:24 6:16 4:42 3:46 3:08

CATEGORY	A	B	C	D	E
S-36	1600/24	701 (700-½)	1600-1½ 701 (700-1½)	1600-1¾ 701 (700-1¾)	1600-2 701 (700-2)
CIRCLING	1600-1	699 (700-1)	1600-2 699 (700-2)	1620-2¼ 719 (700-2¼)	1620-2½ 719 (700-2½)
STABS FIX MINIMUMS					
S-36	1380/24	481 (500-½)	1380/40 481 (500-¾)	1380/50 481 (500-1)	1380/60 481 (500-1½)
CIRCLING	1380-1	479 (500-1)	1520-1¾ 619 (700-1¾)	1620-2¼ 719 (800-2¼)	1620-2½ 719 (800-2½)

LAND AND HOLD-SHORT OPERATIONS (LAHSO)

LAHSO is an acronym for "Land and Hold-Short Operations." These operations include landing and holding short of an intersection runway, an intersecting taxiway, or other predetermined points on the runway other than a runway or taxiway. Measured distance represents the available landing distance on the landing runway, in feet.

Specific questions regarding these distances should be referred to the air traffic manager of the facility concerned. The Aeronautical Information Manual contains specific details on hold-short operations and markings.

CITY/AIRPORT	LDG RWY	HOLD-SHORT POINT	AVBL LDG DIST
DULUTH, MN DULUTH INTL (DLH)	09	03-21	8,950 feet
FARGO, ND HECTOR INTL (FAR)	18 36	13-31 09-27	7,900 feet 6,600 feet
GRAND FORKS, ND GRAND FORKS INTL (GFK)	27R 35L	17R-35L 09L-27R	3,000 feet 4,600 feet
MINNEAPOLIS, MN MINNEAPOLIS-ST PAUL INTL/ WOLD-CHAMBERLAIN (MSP)	22 30L	TWY K TWY A9 TWY W9	8,550 feet 8,150 feet
ROCHESTER, MN ROCHESTER INTL (RST)	03 13 31	13-31 03-21 03-21	5,850 feet 5,270 feet 3,200 feet

22 FEB 2024 to 21 MAR 2024

22 FEB 2024 to 21 MAR 2024

INSTRUMENT APPROACH PROCEDURE CHARTS

A **IFR ALTERNATE AIRPORT MINIMUMS**

Pilots must review the IFR Alternate Minimums Notes to determine alternate airport suitability.

ANA designation on the approach chart means that pilots may not use that approach as an alternate due to unmonitored facility, absence of weather reporting service, or lack of adequate navigation coverage. Approaches with the **A**NA designation are not listed in this section. **A** designation on the approach chart indicates that the approach procedure has non-standard minimums (for aircraft other than helicopters) or restrictions (for all users) for its use as an alternate.

Alternate Minima (ref: 14 CFR 91.169)

	Precision Approach	Non-Precision Approach
Standard	600-2	800-2
A Non-Standard or restrictions	As indicated below	As indicated below
Helicopters	For the selected approach: Ceiling: 200' above published ceiling Visibility: the greater of 1 SM visibility or the published visibility	
US Military (USA/USN/USAF)	See Service Regulations	

Note: For alternate airport flight planning purposes, precision approach operations include: ILS, PAR, and GLS, and Non-Precision approach operations include: NDB, VOR, LOC, TACAN, LDA, SDF, ASR, RNAV (GPS) and RNAV (RNP).

NAME ALTERNATE MINIMUMS

ABERDEEN, SD

ABERDEEN
 RGNL (ABR).....**ILS or LOC Rwy 31¹**
 RNAV (GPS) Rwy 13²
 RNAV (GPS) Rwy 17²
 RNAV (GPS) Rwy 31²
 RNAV (GPS) Rwy 35²
 VOR Rwy 13²
 VOR Rwy 31²

¹LOC, Category D, 900-2½.
²Category D, 900-2½.

AITKIN, MN

AITKIN MUNI/STEVE KURTZ
 FLD (AIT).....**RNAV (GPS) Rwy 16**
 RNAV (GPS) Rwy 34
 NA when local weather not available.

ALBERT LEA, MN

ALBERT LEA
 MUNI (AEL).....**RNAV (GPS) Rwy 17**
 RNAV (GPS) Rwy 35
 VOR Rwy 17¹
 VOR Rwy 35²

NA when local weather not available.
¹Category C, 800-2½, Category D, 800-2½.
²Category D, 800-2½.

NAME ALTERNATE MINIMUMS

ALEXANDRIA, MN

CHANDLER
 FLD (AXN).....**RNAV (GPS) Rwy 4**
 RNAV (GPS) Rwy 13
 RNAV (GPS) Rwy 22
 RNAV (GPS) Rwy 31
 NA when local weather not available.

APPLETON, MN

APPLETON
 MUNI (AQP).....**RNAV (GPS) Rwy 13**
 NA when local weather not available.
 Category C, 900-2½.

AUSTIN, MN

AUSTIN
 MUNI (AUM).....**RNAV (GPS) Rwy 17**
 RNAV (GPS) Rwy 35
 NA when local weather not available.

BAUDETTE, MN

BAUDETTE
 INTL (BDE).....**RNAV (GPS) Rwy 12**
 RNAV (GPS) Rwy 30¹

NA when local weather not available.
¹Categories A, B, C, D, 900-4.

NAME ALTERNATE MINIMUMS

BEMIDJI, MN

BEMIDJI
RGNL (BJI).....RNAV (GPS) Rwy 13
RNAV (GPS) Rwy 25
RNAV (GPS) Rwy 31

NA when local weather not available.

BENSON, MN

BENSON
MUNI (BBB).....RNAV (GPS) Rwy 14
RNAV (GPS) Rwy 32

NA when local weather not available.

BIGFORK, MN

BIGFORK
MUNI (FOZ).....RNAV (GPS) Rwy 33

NA when local weather not available.

BISMARCK, ND

BISMARCK
MUNI (BIS).....ILS or LOC Rwy 13¹²
ILS or LOC Rwy 31¹²
RADAR-1¹³
RNAV (GPS) Rwy 3³
RNAV (GPS) Rwy 13³
RNAV (GPS) Rwy 21³
RNAV (GPS) Rwy 31³
VOR-A³

¹NA when control tower closed.

²LOC, Category C, 800-2¼, Category D, 800-2½.

³Category C, 800-2¼, Category D, 800-2½.

BOWMAN, ND

BOWMAN
RGNL (BWW).....RNAV (GPS) Rwy 13
RNAV (GPS) Rwy 31

NA when local weather not available.

BRAINERD, MN

BRAINERD LAKES
RGNL (BRD).....ILS or LOC Rwy 23¹
RNAV (GPS) Rwy 5
RNAV (GPS) Rwy 23
RNAV (GPS) Rwy 34

NA when local weather not available.

¹Category D, 700-2.

BRITTON, SD

BRITTON MUNI (BTN).....RNAV (GPS) Rwy 13
RNAV (GPS) Rwy 31

NA when local weather not available.

BROOKINGS, SD

BROOKINGS
RGNL (BKK).....RNAV (GPS) Rwy 12
RNAV (GPS) Rwy 30

NA when local weather not available.

Category D, 800-2¼.

NAME ALTERNATE MINIMUMS

BUFFALO, MN

BUFFALO
MUNI (CFE).....VOR-A
NA when local weather not available.

CAMBRIDGE, MN

CAMBRIDGE
MUNI (CBG).....RNAV (GPS) Rwy 16
RNAV (GPS) Rwy 34

NA when local weather not available.

CANBY, MN

MYERS FLD (CNB).....RNAV (GPS) Rwy 12
RNAV (GPS) Rwy 30

NA when local weather not available.

Category D, 800-2½.

CARRINGTON, ND

CARRINGTON
MUNI (46D).....RNAV (GPS) Rwy 31

NA when local weather not available.

CAVALIER, ND

CAVALIER
MUNI (2C8).....RNAV (GPS) Rwy 34

NA when local weather not available.

CLOQUET, MN

CLOQUET/CARLTON
COUNTY (COQ).....RNAV (GPS) Rwy 18
RNAV (GPS) Rwy 36

NA when local weather not available.

COOK, MN

COOK MUNI (CQM).....RNAV (GPS) Rwy 13
RNAV (GPS) Rwy 31

NA when local weather not available.

CROOKSTON, MN

CROOKSTON MUNI/KIRKWOOD
FLD (CKN).....RNAV (GPS) Rwy 13
RNAV (GPS) Rwy 31
VOR/DME Rwy 13

NA when local weather not available.

CROSBY, ND

CROSBY
MUNI (D50).....RNAV (GPS) Rwy 30

NA when local weather not available.

Category D, 800-2¼.

DETROIT LAKES, MN

DETROIT LAKES/WETHING
FLD (DTL).....RNAV (GPS) Rwy 14
RNAV (GPS) Rwy 32

NA when local weather not available.

Category D, 800-2½.

22 FEB 2024 to 21 MAR 2024

22 FEB 2024 to 21 MAR 2024

NAME ALTERNATE MINIMUMS

DEVILS LAKE, ND

DEVILS LAKE
RGNL (DVL).....RNAV (GPS) Rwy 3
RNAV (GPS) Rwy 13
RNAV (GPS) Rwy 21
RNAV (GPS) Rwy 31

NA when local weather not available.
Category C, 800-2¼, Category D, 800-2½.

DICKINSON, ND

DICKINSON/THEODORE ROOSEVELT
RGNL (DIK).....RNAV (GPS) Rwy 7
RNAV (GPS) Rwy 14
RNAV (GPS) Rwy 25
RNAV (GPS) Rwy 32
VOR-A

NA when local weather not available.

DODGE CENTER, MN

DODGE CENTER (TOB).....RNAV (GPS) Rwy 16
RNAV (GPS) Rwy 34
VOR-A

NA when local weather not available.

DULUTH, MN

DULUTH INTL (DLH).....ILS or LOC Rwy 9¹
ILS or LOC Rwy 27¹
RADAR-1²
RNAV (GPS) Rwy 3³
RNAV (GPS) Rwy 9²
RNAV (GPS) Rwy 21³
RNAV (GPS) Rwy 27³
TACAN Y Rwy 9⁴
VOR or TACAN Rwy 3²
VOR/DME or TACAN Rwy 21²

¹LOC, Categories D, E, 1000-3.

²Categories D, E, 1000-3.

³Category D, 1000-3.

⁴Category E, 800-2¼.

SKY HARBOR (DYT).....RNAV (GPS) Rwy 32
NA when local weather not available.

ELY, MN

ELY MUNI (ELO).....RNAV (GPS) Rwy 12
RNAV (GPS) Rwy 30

NA when local weather not available.
Category D, 1000-3.

EVELETH, MN

EVELETH/VIRGINIA
MUNI (EVM).....RNAV (GPS) Rwy 27
VOR-A

NA when local weather not available.
Category C, 900-2¼; Category D, 1100-3.

NAME ALTERNATE MINIMUMS

FAIRMONT, MN

FAIRMONT MUNI (FRM).....RNAV (GPS) Rwy 13
RNAV (GPS) Rwy 31

NA when local weather not available.
Category C, 900-2¼; Category D, 900-2¼.

FARGO, ND

HECTOR INTL (FAR).....ILS or LOC Rwy 18¹
ILS or LOC Rwy 36¹
RNAV (GPS) Rwy 9³
RNAV (GPS) Rwy 18²
RNAV (GPS) Rwy 27³
RNAV (GPS) Rwy 36²
VOR Rwy 36²

¹ILS, Category C, 700-2; Category D, 800-2¼;
Category E, 800-2½. LOC, Category D,
800-2¼; Category E, 800-2½.

²Category D, 800-2¼, Category E, 800-2½.

³Category D, 800-2¼.

FARIBAULT, MN

FARIBAULT MUNI-LIZ WALL STROHFUS
FLD (FBL).....RNAV (GPS) Rwy 12
RNAV (GPS) Rwy 30

NA when local weather not available.

FERGUS FALLS, MN

FERGUS FALLS MUNI/EINAR MICKELSON
FLD (FFM).....RNAV (GPS) Rwy 13¹
RNAV (GPS) Rwy 31¹
RNAV (GPS) Rwy 35

NA when local weather not available.

¹Category D, 800-2¼.

FOSSTON, MN

FOSSTON MUNI/ANDERSON
FLD (FSE).....RNAV (GPS) Rwy 16
RNAV (GPS) Rwy 34

NA when local weather not available.

GLENCOE, MN

GLENCOE
MUNI (GYL).....RNAV (GPS) Rwy 31
NA when local weather not available.

GLENWOOD, MN

GLENWOOD
MUNI (GHW).....RNAV (GPS) Rwy 15
RNAV (GPS) Rwy 33

NA when local weather not available.

22 FEB 2024 to 21 MAR 2024

22 FEB 2024 to 21 MAR 2024

NAME ALTERNATE MINIMUMS

GRAND FORKS, ND

GRAND FORKS
INTL (GFK).....**ILS or LOC Rwy 35L**¹²
LOC BC Rwy 17R¹
RNAV (GPS) Rwy 9L
RNAV (GPS) Rwy 17R
RNAV (GPS) Rwy 27R
VOR Rwy 17R

NA when local weather not available.
¹NA when control tower closed.
²ILS, Category E, 700-2½;
LOC, Category E, 800-2½.

GRAND MARAIS, MN

GRAND MARAIS/ COOK
COUNTY (CKC).....**RNAV (GPS) Rwy 10**
RNAV (GPS) Rwy 28¹

Category D, 900-2¼.
¹NA when local weather not available.

GRAND RAPIDS, MN

GRAND RAPIDS/ITASCA COUNTY-GORDON
NEWSTROM FLD (GPZ).....**ILS or LOC Rwy 34**
RNAV (GPS) Rwy 16
RNAV (GPS) Rwy 34
VOR Rwy 34

NA when local weather not available.

GRANITE FALLS, MN

GRANITE FALLS MUNI/LENZEN-ROE-FAGEN-
MEML FLD (GDB).....**RNAV (GPS) Rwy 33**
VOR/DME Rwy 33

NA when local weather not available.

GWINNER, ND

GWINNER-ROGER MELROE
FIELD (GWR).....**RNAV (GPS) Rwy 16**
RNAV (GPS) Rwy 34

NA when local weather not available.
Category D, 800-2½.

HALLOCK, MN

HALLOCK MUNI (HCO).....**RNAV (GPS) Rwy 13**
RNAV (GPS) Rwy 31

NA when local weather not available.

HAZEN, ND

MERCER COUNTY
RGNL (HZE).....**RNAV (GPS) Rwy 15**
RNAV (GPS) Rwy 33

NA when local weather not available.

HETTINGER, ND

HETTINGER/JB LINDQUIST
RGNL (HEI).....**RNAV (GPS) Rwy 12**
RNAV (GPS) Rwy 30

Category D, 800-2¼.

NAME ALTERNATE MINIMUMS

HIBBING, MN

RANGE RGNL (HIB).....**ILS OR LOC/DME Rwy 13¹**
RNAV (GPS) Rwy 13²
RNAV (GPS) Rwy 31²

¹ILS, Categories A, B, C, D, 800-2.
²NA when local weather not available.

HURON, SD

HURON RGNL (HON).....**ILS or LOC Rwy 12¹**
LOC BC Rwy 30²
RNAV (GPS) Rwy 12²
RNAV (GPS) Rwy 30²

NA when local weather not available.
¹LOC, Category D, 800-2¼.
²Category D, 800-2¼.

HUTCHINSON, MN

HUTCHINSON MUNI/BUTLER
FLD (HCD).....**RNAV (GPS) Rwy 15**
NA when local weather not available.

INTERNATIONAL FALLS, MN

FALLS INTL/EINARSON
FLD (INL).....**COPTER ILS or LOC Rwy 31**
ILS or LOC Rwy 31¹
RNAV (GPS) Rwy 13²
RNAV (GPS) Rwy 31²
VOR Rwy 13²
VOR Rwy 31²

NA when local weather not available.
¹LOC, Category D, 800-2¼.
²Category D, 800-2¼.

JACKSON, MN

JACKSON (MJQ).....**RNAV (GPS) Rwy 14**
RNAV (GPS) Rwy 32

NA when local weather not available.

JAMESTOWN, ND

JAMESTOWN
RGNL (JMS).....**RNAV (GPS) Rwy 4**
RNAV (GPS) Rwy 13
RNAV (GPS) Rwy 22
RNAV (GPS) Rwy 31
VOR Rwy 13
VOR Rwy 31

Category D, 800 2½.

LANGDON, ND

ROBERTSON
FLD (D55).....**RNAV (GPS) Rwy 14**
RNAV (GPS) Rwy 32¹

NA when local weather not available.
¹Category C, 800-2¼.

LONG PRAIRIE, MN

TODD FLD (14Y).....**RNAV (GPS) Rwy 34**
NA when local weather not available.

22 FEB 2024 to 21 MAR 2024

22 FEB 2024 to 21 MAR 2024

NAME ALTERNATE MINIMUMS

LONGVILLE, MN

LONGVILLE
MUNI (XVG).....RNAV (GPS) Rwy 13
RNAV (GPS) Rwy 31

NA when local weather not available.

LITCHFIELD, MN

LITCHFIELD
MUNI (LJF).....RNAV (GPS) Rwy 13
RNAV (GPS) Rwy 31
VOR-A

NA when local weather not available.
Category D, 1000-3.

LITTLE FALLS, MN

LITTLE FALLS/MORRISON COUNTY-
LINDBERGH FLD (LXL).....RNAV (GPS) Rwy 31

NA when local weather not available.

LINTON, ND

LINTON MUNI (7L2).....RNAV (GPS) Rwy 9
RNAV (GPS) Rwy 27

NA when local weather not available.

LUVERNE, MN

QUENTIN AANENSON
FLD (LYV).....RNAV (GPS) Rwy 18
RNAV (GPS) Rwy 36

NA when local weather not available.
Category C, 1000-2¼; Category D, 1000-3.

MADISON, MN

LAC QUI PARLE
COUNTY (DXX).....RNAV (GPS) Rwy 14
RNAV (GPS) Rwy 32

NA when local weather not available

MADISON, SD

MADISON MUNI (MDS).....RNAV (GPS) Rwy 15
RNAV (GPS) Rwy 33

NA when local weather not available.
Category D, 800-2¼.

MAHNOMEN, MN

MAHNOMEN
COUNTY (3N8).....RNAV (GPS) Rwy 17
RNAV (GPS) Rwy 35

NA when local weather not available

MANDAN, ND

MANDAN RGNL/LAWLER
FLD (Y19).....RNAV (GPS) Rwy 13
RNAV (GPS) Rwy 31
VOR-A

NA when local weather not available

NAME ALTERNATE MINIMUMS

MANKATO, MN

MANKATO RGNL
(MKT).....RNAV (GPS) Rwy 4
RNAV (GPS) Rwy 15
RNAV (GPS) Rwy 22
RNAV (GPS) Rwy 33

NA when local weather not available.

MAPLE LAKE, MN

MAPLE LAKE MUNI-BILL MAVENCAMP
SR FLD (MGG).....RNAV (GPS)-A

NA when local weather not available.

MARSHALL, MN

SOUTHWEST MINNESOTA RGNL MARSHALL/
RYAN FLD (MML).....RNAV (GPS) Rwy 12
RNAV (GPS) Rwy 30

NA when local weather not available.

MINNEAPOLIS, MN

AIRLAKE (LVN).....RNAV (GPS) Rwy 12¹
RNAV (GPS) Rwy 30²
VOR Rwy 12¹

¹Category D, 800-2¼.

²NA when local weather not available.

ANOKA COUNTY/BLAINE

(JANES FLD) (ANE).....ILS or LOC Rwy 27
RNAV (GPS) Rwy 27

NA when local weather not available.

CRYSTAL (MIC).....RNAV (GPS) Rwy 14
RNAV (GPS) Rwy 32

NA when local weather not available.

FLYING CLOUD

(FCM).....COPTER ILS or LOC Rwy 10R¹
ILS or LOC Rwy 10R¹²
RNAV (GPS) Rwy 10L
RNAV (GPS) Rwy 10R
RNAV (GPS) Rwy 28L
RNAV (GPS) Rwy 28R
RNAV (GPS) Rwy 36
VOR Rwy 10R
VOR/DME Rwy 36

NA when local weather not available.

¹NA when control tower closed.

²Category D, 700-2.

22 FEB 2024 to 21 MAR 2024

22 FEB 2024 to 21 MAR 2024

NAME ALTERNATE MINIMUMS

MINNEAPOLIS, MN (CON'T)

MINNEAPOLIS-ST. PAUL INTL/WOLD-
CHAMBERLAIN (MSP).....**ILS or LOC Rwy 12L**¹
ILS or LOC Rwy 12R¹
ILS or LOC Rwy 30L²
ILS or LOC Rwy 30R²
ILS Z or LOC Rwy 35²
LOC Rwy 4³
LOC Rwy 17⁴
LOC Rwy 22⁵
RNAV (GPS) Rwy 4³
RNAV (GPS) Rwy 22³
RNAV (GPS) Z Rwy 12L³
RNAV (GPS) Z Rwy 12R³
RNAV (GPS) Z Rwy 30L³
RNAV (GPS) Z Rwy 30R³
RNAV (GPS) Z Rwy 35³

¹ILS, Category C, 700-2; Category D, 900-2¼;
 Category E, 1000-3; LOC, Category D, 900-2¼;
 Category E, 1000-3.
²ILS, Category C, 700-2; Category D, 900-2¼;
 Category E, 1000-3; LOC, Category D, 900-2¼;
 Category E, 1000-3.
³Category D, 900-2¼; Category E, 1000-3.
⁴Category D, 900-2¼.
⁵Category D, 800-2½; Category E, 1000-3.

MINOT, ND

MINOT INTL (MOT).....**ILS or LOC Rwy 31**¹²
LOC BC Rwy 13¹³
RNAV (GPS) Rwy 8³
RNAV (GPS) Rwy 13³
RNAV (GPS) Rwy 26³
RNAV (GPS) Rwy 31³
VOR Rwy 8⁴
VOR Rwy 13³
VOR Rwy 26⁵
VOR Rwy 31³

NA when local weather not available.
¹NA when control tower closed.
²LOC, Categories C, D, E, 1100-3.
³Categories C, D, 1100-3.
⁴Categories A, B, 1100-2; Categories C, D, 1100-3.
⁵Categories A, B, 900-2; Categories C, D, 1100-3.

MITCHELL, SD

MITCHELL MUNI (MHE).....**RNAV (GPS) Rwy 13**
RNAV (GPS) Rwy 18
RNAV (GPS) Rwy 31
RNAV (GPS) Rwy 36
VOR Rwy 13

NA when local weather not available.

MOBRIDGE, SD

MOBRIDGE MUNI (MBG).....**RNAV (GPS) Rwy 12**
RNAV (GPS) Rwy 30

NA when local weather not available
 Category D, 900-2¼.

NAME ALTERNATE MINIMUMS

MONTEVIDEO, MN

MONTEVIDEO-CHIPPEWA
COUNTY (MVE).....**RNAV (GPS) Rwy 14**
RNAV (GPS) Rwy 32

NA when local weather not available.

MOORHEAD, MN

MOORHEAD MUNI/FLORENCE
KLINGENSMITH FLD (JKJ)...**RNAV (GPS) Rwy 30**¹
VOR-A²

¹NA when local weather not available.
²Category A, B, 900-2.

MORA, MN

MORA MUNI (JMR).....**RNAV (GPS) Rwy 35**
 NA when local weather not available.
 Category D, 800-2¼.

MORRIS, MN

MORRIS MUNI/CHARLIE SCHMIDT
FLD (MOX).....**RNAV (GPS) Rwy 14**
RNAV (GPS) Rwy 32

NA when local weather not available.

ORR, MN

ORR RGNL (ORB).....**RNAV (GPS) Rwy 13**
 NA when local weather not available.
 Category C, 900-2¼.

ORTONVILLE, MN

ORTONVILLE MUNI/MARTINSON
FLD (VVV).....**RNAV (GPS) Rwy 34**
 NA when local weather not available.

OWATONNA, MN

OWATONNA DEGNER
RGNL (OWA).....**RNAV (GPS) Rwy 12**
RNAV (GPS) Rwy 30

NA when local weather not available.
 Category D, 800-2¼.

PARK RAPIDS, MN

PARK RAPIDS MUNI/KONSHOK
FLD (PKD).....**RNAV (GPS) Rwy 13**
RNAV (GPS) Rwy 31

NA when local weather not available.
 Category D, 1100-3.

PAYNESVILLE, MN

PAYNESVILLE
MUNI (PEX).....**RNAV (GPS) Rwy 11**
RNAV (GPS) Rwy 29

NA when local weather not available.

PHILIP, SD

PHILIP (PHP).....**RNAV (GPS) Rwy 12**
RNAV (GPS) Rwy 30
VOR-A

NA when local weather not available.

22 FEB 2024 to 21 MAR 2024

22 FEB 2024 to 21 MAR 2024

NAME ALTERNATE MINIMUMS

PIERRE, SD

PIERRE RGNL (PIR).....ILS or LOC Rwy 31¹²
RNAV (GPS) Rwy 7¹³
RNAV (GPS) Rwy 13³
RNAV (GPS) Rwy 25³
RNAV (GPS) Rwy 31³
VOR/DME or TACAN Rwy 7¹³
VOR or TACAN Rwy 25¹³

¹NA when local weather not available.

²LOC, Category D, 800-2¼.

³Category D, 800-2¼.

PINE RIDGE, SD

PINE RIDGE (IEN).....RNAV (GPS) Rwy 12¹
RNAV (GPS) Rwy 30²

¹Category C, 900-2½.

²Categories A, B, 900-2.

PIPESTONE, MN

PIPESTONE
MUNI (PQN)..... RNAV (GPS) Rwy 18
RNAV (GPS) Rwy 36

NA when local weather not available.

PRESTON, MN

FILLMORE
COUNTY (FKA).....RNAV (GPS) Rwy 11
RNAV (GPS) Rwy 29

NA when local weather not available.

PRINCETON, MN

PRINCETON
MUNI (PNM).....RNAV (GPS) Rwy 16
RNAV (GPS) Rwy 34

NA when local weather not available.

RAPID CITY, SD

RAPID CITY
RGNL (RAP).....ILS or LOC Rwy 32¹
RNAV (GPS) Rwy 5²
RNAV (GPS) Rwy 14²³
RNAV (GPS) Rwy 23²
RNAV (GPS) Rwy 32⁴
VOR or TACAN Rwy 14²⁴
VOR or TACAN Rwy 32²⁴

¹ILS, Categories B, C, 700-2; Category D, 800-2¼; Category E, 800-2¼. LOC, Category D, 800-2¼; Category E, 800-2¼.

²NA when local weather not available.

³Category D, 800-2¼; Category E, 800-2½.

⁴Category D, 800-2¼; Category E, 800-2¼.

RAY S. MILLER AAF (KRYM)

CAMP RILEY, MN.....ILS or LOC Rwy 31

NA when control tower closed.

NAME ALTERNATE MINIMUMS

RED WING, MN

RED WING
RGNL (RGK).....RNAV (GPS) Rwy 9¹
RNAV (GPS) Rwy 27²

NA when local weather not available.

¹Category C, 900-2½, Category D, 1000-3.

²Category C, 900-2½.

REDWOOD FALLS, MN

REDWOOD FALLS
MUNI (RWF).....RNAV (GPS) Rwy 30
VOR-A

Category D, 800-2¼.

NA when local weather not available.

ROCHESTER, MN

ROCHESTER
INTL (RST).....ILS or LOC Rwy 13
ILS Z or LOC Z Rwy 31
COPTER ILS Y or LOC Y Rwy 31
RADAR-1

NA when control tower closed.

ROLLA, ND

ROLLA MUNI/LEONARD
KRECH FLD (06D).....RNAV (GPS) Rwy 32

NA when local weather not available.

Category D, 900-2¼.

ROSEAU, MN

ROSEAU MUNI/RUDY BILLBERG
FLD (ROX).....RNAV (GPS) Rwy 16
RNAV (GPS) Rwy 34

NA when local weather not available.

Category C, 800-2¼; Category D, 800-2½.

RUGBY, ND

RUGBY MUNI (RUG).....RNAV (GPS) Rwy 30

NA when local weather not available.

RUSH CITY, MN

RUSH CITY
RGNL (ROS).....RNAV (GPS) Rwy 34

NA when local weather not available.

ST CLOUD, MN

ST CLOUD
RGNL (STC).....ILS or LOC/DME Rwy 13¹²³
RNAV (GPS) Rwy 5¹
RNAV (GPS) Rwy 13¹⁴
RNAV (GPS) Rwy 23¹
RNAV (GPS) Rwy 31¹⁴
VOR Rwy 31²⁴

¹NA when local weather not available.

²NA when control tower closed.

³LOC, Category D, 900-2¼.

⁴Category D, 900-2¼.

NAME ALTERNATE MINIMUMS

ST. JAMES, MN

ST. JAMES
MUNI (JYG).....**RNAV (GPS) Rwy 15**
RNAV (GPS) Rwy 33

NA when local weather not available.

ST. PAUL, MN

LAKE ELMO (21D).....**RNAV (GPS) Rwy 14**
RNAV (GPS) Rwy 32

NA when local weather not available.

SAINT PAUL DOWNTOWN HOLMAN

FLD (STP).....**ILS or LOC Rwy 14¹²**
ILS or LOC Rwy 32¹²
RNAV (GPS) Rwy 14³
RNAV (GPS) Rwy 32³⁴

¹NA when control tower closed.

²LOC, Categories A, B, 900-2; Category C, 900-2½; Category D, 900-2¾.

³Categories A, B, 900-2; Category C, 900-2½; Category D, 900-2¾.

⁴NA when local weather not available.

SAUK CENTRE, MN

SAUK CENTRE
MUNI (D39).....**RNAV (GPS) Rwy 14**
RNAV (GPS) Rwy 32

NA when local weather not available.

SIoux FALLS, SD

JOE FOSS
FLD (FSD).....**ILS or LOC Rwy 3¹²**
ILS or LOC Rwy 21¹²
RADAR-1³
RNAV (GPS) Rwy 3⁴⁵
RNAV (GPS) Rwy 15⁴⁵
RNAV (GPS) Rwy 21⁴
RNAV (GPS) Rwy 33⁴⁵
VOR or TACAN Rwy 15⁶
VOR/DME or TACAN Rwy 33⁶

¹NA when control tower closed.

²LOC, Category D, 800-2½.

³Category E, 800-2¾.

⁴Category D, 800-2½.

⁵NA when local weather not available.

⁶Category D, 800-2½; Category E, 900-3.

SLAYTON, MN

SLAYTON MUNI (DVP).....**RNAV (GPS) Rwy 17**
RNAV (GPS) Rwy 35

NA when local weather not available.

SOUTH ST. PAUL, MN

SOUTH ST PAUL MUNI/RICHARD E
FLEMING FLD (SGS).....**RNAV (GPS) Rwy 34**
Category D, 800-2½.

NAME ALTERNATE MINIMUMS

SPEARFISH, SD

BLACK HILLS-
CLYDE ICE FLD (SPF).....**RNAV (GPS) Rwy 13¹**
RNAV (GPS) Rwy 31²

¹Categories A, B, 1000-4, Category C, 1700-4.

²Categories A, B, 1000-2, Category C, 1700-3.

STANLEY, ND

STANLEY MUNI (08D).....**RNAV (GPS) Rwy 28**
NA when local weather not available.

STAPLES, MN

STAPLES MUNI (SAZ).....**RNAV (GPS) Rwy 14**
RNAV (GPS) Rwy 32

NA when local weather not available.

THIEF RIVER FALLS, MN

THIEF RIVER
FALLS RGNL (TVF).....**ILS or LOC Rwy 31¹**
RNAV (GPS) Rwy 4²
RNAV (GPS) Rwy 13²³
RNAV (GPS) Rwy 22²
RNAV (GPS) Rwy 31²³
VOR Y Rwy 13³
VOR Rwy 31³

¹LOC, Category D, 900-2¾.

²NA when local weather not available.

³Category D, 900-2¾.

TIOGA, ND

TIOGA
MUNI (D60).....**RNAV (GPS) Rwy 12**
RNAV (GPS) Rwy 30¹

Category D, 800-2¾.

¹NA when local weather not available.

TRACY, MN

TRACY MUNI (TKC).....**RNAV (GPS) Rwy 11**
RNAV (GPS) Rwy 29

NA when local weather not available.

TWO HARBORS, MN

RICHARD B.
HELGESON (TWM).....**RNAV (GPS) Rwy 6**
RNAV (GPS) Rwy 24

NA when local weather not available.

VALLEY CITY, ND

BARNES COUNTY
MUNI (BAC).....**RNAV (GPS) Rwy 13**
RNAV (GPS) Rwy 31

NA when local weather not available.

WADENA, MN

WADENA MUNI (ADC).....**RNAV (GPS) Rwy 16**
RNAV (GPS) Rwy 34

NA when local weather not available.

NAME ALTERNATE MINIMUMS

WAHPETON, ND

HARRY
STERN (BWP).....RNAV (GPS) Rwy 33
NA when local weather not available.
Category D, 800-2¼.

WALHALLA, ND

WALHALLA MUNI (96D).....RNAV (GPS) Rwy 33
NA when local weather not available.
Category B, 1100-2.

WALKER, MN

WALKER MUNI (Y49).....RNAV (GPS) Rwy 15
RNAV (GPS) Rwy 33
NA when local weather not available.
Category C, 800-2¼.

WARROAD, MN

WARROAD INTL
MEML (RRT).....RNAV (GPS) Rwy 13
RNAV (GPS) Rwy 31
NA when local weather not available.
Category C, 900-2¾; Category D, 900-3.

WASECA, MN

WASECA MUNI/MAYNARD RICHARD
STENSRUD FLD (ACQ).....RNAV (GPS) Rwy 15
RNAV (GPS) Rwy 33
NA when local weather not available.

WATERTOWN, SD

WATERTOWN
RGNL (ATY).....ILS or LOC Rwy 35¹
RNAV (GPS) Rwy 12²
RNAV (GPS) Rwy 17²
RNAV (GPS) Rwy 30²
RNAV (GPS) Rwy 35²

NA when local weather not available.
¹LOC, Category C, 800-2¼; Category D, 800-2½.
²Category C, 800-2¼; Category D, 800-2½.

WATFORD CITY, ND

WATFORD CITY
MUNI (S25).....RNAV (GPS) Rwy 30
NA when local weather not available.
Category D, 900-2¼.

WHEATON, MN

WHEATON MUNI (ETH).....RNAV (GPS) Rwy 16
RNAV (GPS) Rwy 34
NA when local weather not available.

NAME ALTERNATE MINIMUMS

WILLISTON, ND

WILLISTON BASIN
INTL (XWA).....RNAV (GPS) Rwy 4
RNAV (GPS) Rwy 14
RNAV (GPS) Rwy 22
RNAV (GPS) Rwy 32
VOR Rwy 14
VOR Rwy 22
VOR Rwy 32

NA when local weather not available.

WILLMAR, MN

WILLMAR MUNI/JOHN L RICE
FLD (BDH).....RNAV (GPS) Rwy 13¹
RNAV (GPS) Rwy 31
VOR Rwy 31¹

NA when local weather not available.
¹Category D, 900-2¾.

WINDOM, MN

WINDOM MUNI (MWM).....RNAV (GPS) Rwy 17
RNAV (GPS) Rwy 35
NA when local weather not available.

WINNER, SD

WINNER RGNL (ICR).....RNAV (GPS) Rwy 13
RNAV (GPS) Rwy 31
NA when local weather not available.

WINONA, MN

WINONA MUNI-MAX CONRAD
FIELD (ONA).....RNAV (GPS) Rwy 12¹
RNAV (GPS) Rwy 30²

¹Categories A, B, 1000-2; Category C, 1200-3;
Category D, 1400-3.
²NA when local weather not available.

WORTHINGTON, MN

WORTHINGTON
MUNI (OTG).....ILS or LOC Rwy 29¹
RNAV (GPS) Rwy 11²
RNAV (GPS) Rwy 18²
RNAV (GPS) Rwy 29²
RNAV (GPS) Rwy 36²

NA when local weather not available.
¹LOC, Category D, 800-2½.
²Category D, 800-2½.

YANKTON, SD

CHAN GURNEY
MUNI (YKN).....RNAV (GPS) Rwy 13
RNAV (GPS) Rwy 31

NA when local weather not available.
Category D, 800-2¼.

TAKEOFF MINIMUMS, (OBSTACLE) DEPARTURE PROCEDURES, AND DIVERSE VECTOR AREA (RADAR VECTORS)

24025

INSTRUMENT APPROACH PROCEDURE CHARTS

IFR TAKEOFF MINIMUMS AND (OBSTACLE) DEPARTURE PROCEDURES

Civil Airports and Selected Military Airports

ALL USERS: Airports that have Departure Procedures (DPs) designed specifically to assist pilots in avoiding obstacles during the climb to the minimum enroute altitude, and/or airports that have civil IFR takeoff minimums other than standard, are listed below. Takeoff Minimums and Departure Procedures apply to all runways unless otherwise specified. An entry may also be listed that contains only Takeoff Obstacle Notes. Altitudes, unless otherwise indicated, are minimum altitudes in MSL.

DPs specifically designed for obstacle avoidance are referred to as Obstacle Departure Procedures (ODPs) and are textually described below, or published separately as a graphic procedure. If the ODP is published as a graphic procedure, its name will be listed below, and it can be found in either this volume (civil), or the applicable military volume, as appropriate. Users will recognize graphic obstacle DPs by the term "(OBSTACLE)" included in the procedure title; e.g., TETON TWO (OBSTACLE). If not specifically assigned an ODP, SID, or RADAR vector as part of an IFR clearance, an ODP may be required to be flown for obstacle clearance, even though not specifically stated in the IFR clearance. When doing so in this manner, ATC should be informed when the ODP being used contains a specified route to be flown, restrictions before turning, and/or altitude restrictions.

Some ODPs, which are established solely for obstacle avoidance, require a climb in visual conditions to cross the airport, a fix, or a NAVAID in a specified direction, at or above a specified altitude. These procedures are called Visual Climb Over Airport (VCOA). To ensure safe and efficient operations, the pilot must verbally request approval from ATC to fly the VCOA when requesting their IFR clearance.

At some locations where an ODP has been established, a diverse vector area (DVA) may be created to allow RADAR vectors to be used in lieu of an ODP. DVA information will state that headings will be as assigned by ATC and climb gradients, when applicable, will be published immediately following the specified departure procedure.

Graphic DPs designed by ATC to standardize traffic flows, ensure aircraft separation and enhance capacity are referred to as "Standard Instrument Departures (SIDs)". SIDs also provide obstacle clearance and are published under the appropriate airport section. ATC clearance must be received prior to flying a SID.

CIVIL USERS NOTE: Title 14 Code of Federal Regulations Part 91 prescribes standard takeoff rules and establishes takeoff minimums for certain operators as follows: (1) For aircraft, other than helicopters, having two engines or less – one statute mile visibility. (2) For aircraft having more than two engines – one-half statute mile visibility. (3) For helicopters – one-half statute mile visibility. These standard minima apply in the absence of any different minima listed below.

MILITARY USERS NOTE: Civil (nonstandard) takeoff minima are published below. For military takeoff minima, refer to appropriate service directives.

ABERDEEN, SD

ABERDEEN RGNL (ABR)

TAKEOFF MINIMUMS AND (OBSTACLE) DEPARTURE PROCEDURES

AMDT 1 02MAR17 (17061) (FAA)

TAKEOFF OBSTACLE NOTES:

Rwy 13, lt 4' from DER, 1' right of centerline, 1' AGL/1302' MSL.

Sign 12' from DER, 256' left of centerline, 4' AGL/1302' MSL.

Rwy 31, runway end ident, beginning 39' from DER, 125' right of centerline, up to 5' AGL/1304' MSL.

Runway end ident 40' from DER, 126' left of centerline, 5' AGL/1303' MSL.

Tree 1278' from DER, 745' left of centerline, 1351' MSL.

Tree 1309' from DER, 716' left of centerline, 1352' MSL.

ADA/TWIN VALLEY, MN

NORMAN COUNTY ADA/TWIN VALLEY (D00)

TAKEOFF MINIMUMS AND (OBSTACLE) DEPARTURE PROCEDURES

ORIG 13JAN11 (11013) (FAA)

TAKEOFF MINIMUMS:

Rwy 15, 300-2 or std. w/min climb of 205' per NM to 1300, or alternatively, with std. takeoff minimums and a normal 200' per NM climb gradient, takeoff must occur no later than 1300' prior to DER.

TAKEOFF OBSTACLE NOTES:

Rwy 15, tree 176' from DER 383' left of centerline, 50' AGL/999' MSL.

Tree 178' from DER 307' right of centerline, 50' AGL/999' MSL.

Tree 1,305' from DER 493' right of centerline, 50' AGL/1,004' MSL.

Tree 176' from DER 383' left of centerline, 50' AGL/999' MSL.

Rwy 33, tree 85' from DER 282' left of centerline. 50' AGL/989' MSL.

Multiple buildings beginning 2' from DER 468' right of centerline. up to 50' AGL/954' MSL.

TAKEOFF MINIMUMS, (OBSTACLE) DEPARTURE PROCEDURES, AND DIVERSE VECTOR AREA (RADAR VECTORS)

24025

NC-1

TAKEOFF MINIMUMS, (OBSTACLE) DEPARTURE PROCEDURES, AND DIVERSE VECTOR AREA (RADAR VECTORS)

24025

AITKIN, MN

AITKIN MUNI/STEVE KURTZ FLD (AIT)

TAKEOFF MINIMUMS AND (OBSTACLE) DEPARTURE PROCEDURES

AMDT 4 20AUG15 (22055) (FAA)

TAKEOFF MINIMUMS:

Rwys 8, 26, NA-Environmental.

TAKEOFF OBSTACLE NOTES:

Rwy 16, trees beginning 6' from DER, 86' left of centerline, up to 32' AGL/1238' MSL.

Trees and road beginning 239' from DER, 357' left of centerline, up to 59' AGL/1265' MSL.

Trees beginning 335' from DER, 114' right of centerline, up to 54' AGL/1260' MSL.

Trees beginning 1352' from DER, 189' left of centerline, up to 94' AGL/1300' MSL.

Trees beginning 1759' from DER, 5' right of centerline, up to 93' AGL/1299' MSL.

Trees beginning 3354' from DER, 16' left of centerline, up to 100' AGL/1332' MSL.

Trees beginning 3558' from DER, 48' right of centerline, up to 100' AGL/1333' MSL.

Rwy 34, trees beginning 121' from DER, 408' right of centerline, up to 29' AGL/1235' MSL.

Trees beginning 320' from DER, 406' right of centerline, up to 62' AGL/1268' MSL.

Trees beginning 2084' from DER, 108' right of centerline, up to 74' AGL/1280' MSL.

Trees beginning 1906' from DER, 179' left of centerline, up to 82' AGL/1288' MSL.

ALBERT LEA, MN

ALBERT LEA MUNI (AEL)

TAKEOFF MINIMUMS AND (OBSTACLE) DEPARTURE PROCEDURES

AMDT 1 20OCT11 (11293) (FAA)

TAKEOFF OBSTACLE NOTES:

Rwy 5, sign 2074' from DER, 952' right of centerline, 47' AGL/1316' MSL.

Rwy 17, tree 9' from DER, 349' right of centerline, 14' AGL/1263' MSL.

Trees beginning 711' from DER, 121' left of centerline, up to 71' AGL/1330' MSL.

Rwy 23, trees beginning 77' from DER, 259' left of centerline, up to 75' AGL/1324' MSL.

Trees beginning 127' from DER, 326' right of centerline, up to 36' AGL/1285' MSL.

Rwy 35, trees beginning 8' from DER, 397' right of centerline, up to 51' AGL/1290' MSL.

ALEXANDRIA, MN

CHANDLER FLD (AXN)

TAKEOFF MINIMUMS AND (OBSTACLE) DEPARTURE PROCEDURES

AMDT 2 07SEP23 (23250) (FAA)

TAKEOFF OBSTACLE NOTES:

Rwy 4, electrical system 11' from DER, 17' right of centerline, 2' AGL/1421' MSL.

Tree 671' from DER, 659' left of centerline, 1460' MSL.

Trees beginning 761' from DER, 377' left of centerline, up to 1468' MSL.

Trees, pole beginning 968' from DER, 401' left of centerline, up to 1474' MSL.

Trees beginning 1111' from DER, 376' left of centerline, up to 71' AGL/1489' MSL.

Trees beginning 1304' from DER, 661' right of centerline, up to 1464' MSL.

Tree 1841' from DER, 970' right of centerline, 1469' MSL.

Trees beginning 1901' from DER, 643' right of centerline, up to 1474' MSL.

Trees beginning 1934' from DER, 356' left of centerline, up to 88' AGL/1490' MSL.

Tanks beginning 5535' from DER, 1757' right of centerline, up to 151' AGL/1566' MSL.

Rwy 13, traverse ways beginning 57' from DER, 391' left of centerline, up to 1428' MSL.

Traverse ways beginning 136' from DER, 490' right of centerline, up to 1428' MSL.

Tree 165' from DER, 485' left of centerline, 1466' MSL.

Trees beginning 245' from DER, 404' right of centerline, up to 1480' MSL.

Tree 405' from DER, 488' left of centerline, 1468' MSL.

Trees, sign beginning 412' from DER, 537' left of centerline, up to 1474' MSL.

Tree 1808' from DER, 734' left of centerline, 1486' MSL.

Tree 2152' from DER, 927' right of centerline, 1490' MSL.

Tree 4964' from DER, 1794' right of centerline, 100' AGL/1554' MSL.

Rwy 22, sign 18' from DER, 248' left of centerline, 5' AGL/1428' MSL.

Trees, traverse ways beginning 710' from DER, 406' left of centerline, up to 1461' MSL.

Pole 948' from DER, 557' left of centerline, 34' AGL/1465' MSL.

Poles, buildings beginning 1035' from DER, 476' left of centerline, up to 34' AGL/1466' MSL.

Pole, buildings beginning 1194' from DER, 476' left of centerline, up to 36' AGL/1468' MSL.

Tree 1284' from DER, 825' right of centerline, 1460' MSL.

Tree 1421' from DER, 835' right of centerline, 1465' MSL.

Tree 1915' from DER, 840' left of centerline, 1494' MSL.

Trees beginning 2086' from DER, 612' left of centerline, up to 75' AGL/1499' MSL.

Tree 2115' from DER, 255' right of centerline, 92' AGL/1492' MSL.

Rwy 31, trees beginning 110' from DER, 318' right of centerline, up to 1426' MSL.

Tree 469' from DER, 510' right of centerline, 1429' MSL.

22 FEB 2024 to 21 MAR 2024

22 FEB 2024 to 21 MAR 2024

TAKEOFF MINIMUMS, (OBSTACLE) DEPARTURE PROCEDURES, AND DIVERSE VECTOR AREA (RADAR VECTORS)

24025

TAKEOFF MINIMUMS, (OBSTACLE) DEPARTURE PROCEDURES, AND DIVERSE VECTOR AREA (RADAR VECTORS)

24025

APPLETON, MN

APPLETON MUNI (AQP)

TAKEOFF MINIMUMS AND (OBSTACLE) DEPARTURE PROCEDURES

ORIG-B 19MAY22 (22139) (FAA)

TAKEOFF MINIMUMS:

Rwys 4, 22, NA-Environmental.

DEPARTURE PROCEDURE:

Rwy 13, climb on heading 130° to 2500 before turning right.**Rwy 31**, climb on heading 300° to 2000 before turning left.

TAKEOFF OBSTACLE NOTES:

Rwy 13, trees beginning 91' from DER, 464' left of centerline, up to 100' AGL/1134' MSL.

Trees beginning 576' from DER, 388' right of centerline, up to 100' AGL/1120' MSL.

AUSTIN, MN

AUSTIN MUNI (AUM)

TAKEOFF MINIMUMS AND (OBSTACLE) DEPARTURE PROCEDURES

ORIG 14FEB08 (08045) (FAA)

TAKEOFF OBSTACLE NOTES:

Rwy 17, Multiple trees beginning 809' from DER, 663' right of centerline, up to 61' AGL/1285' MSL.**Rwy 35**, Tree 1380' from DER, 484' right of centerline, 100' AGL/1314' MSL.

BEACH, ND

BEACH (20U)

TAKEOFF MINIMUMS AND (OBSTACLE) DEPARTURE PROCEDURES

ORIG 21JUL16 (16203) (FAA)

DEPARTURE PROCEDURE:

Rwy 12, climb heading 125° to 4000 before turning left.

TAKEOFF OBSTACLE NOTES:

Rwy 12, airfield lt 9' from DER, 27' right of centerline, 2749' MSL.

Vehicles on road beginning 39' from DER, 371' right of centerline, up to 2764' MSL.

Terrain 95' from DER, 416' left of centerline, 2751' MSL.

Vehicles on road beginning 444' from DER, 379' right of centerline, up to 2766' MSL.

Vehicle on road 1230' from DER, 182' left of centerline, 2780' MSL.

Vehicle on road 1237' from DER, 198' left of centerline, 2781' MSL.

Vehicle on road 1276' from DER, 226' left of centerline, 2782' MSL.

Vehicles on road beginning 1326' from DER, 273' left of centerline, up to 2785' MSL.

Vehicle on road 1474' from DER, 418' left of centerline, 2786' MSL.

Vehicles on road 1652' from DER, 586' left of centerline, 2790' MSL.

Vehicles on road, tree, and building beginning 1671' from DER, 664' left of centerline, up to 2808' MSL.

Rwy 30, airfield lt beginning 10' from DER, 9' right of centerline, up to 1' AGL/2757' MSL.

BAUDETTE, MN

BAUDETTE INTL (BDE)

TAKEOFF MINIMUMS AND (OBSTACLE) DEPARTURE PROCEDURES

AMDT 1A 20JUN19 (19171) (FAA)

TAKEOFF MINIMUMS:

Rwys 13W, 31W, NA - Environmental.

DEPARTURE PROCEDURE:

Rwy 12, climb on heading 116° to 1700 before turning northbound.

TAKEOFF OBSTACLE NOTES:

Rwy 12, tree, pole beginning 5' from DER, 30' left of centerline, up to 1085' MSL.

General utility 61' from DER, 353' right of centerline, 5' AGL/1086' MSL.

Tree, vehicles on road beginning 424' from DER, 60' right of centerline, up to 1116' MSL.

Trees beginning 503' from DER, 538' right of centerline, up to 1121' MSL.

Tree 594' from DER, 139' left of centerline, 1100' MSL.

Water tower, tank beginning 4131' from DER, 1229' right of centerline, up to 1204' MSL.

Rwy 30, lighting 9' from DER, 30' left of centerline, 3' AGL/1086' MSL.

NAVAID 9' from DER, 29' right of centerline, 2' AGL/1086' MSL.

Tree 15' from DER, 349' right of centerline, 1096' MSL.

Trees beginning 16' from DER, 498' right of centerline, up to 1098' MSL.

Tree 341' from DER, 516' right of centerline, 1102' MSL.

Tree 365' from DER, 550' right of centerline, 1106' MSL.

Vehicles on road 724' from DER, 675' left of centerline, 1103' MSL.

Trees beginning 1348' from DER, 745' right of centerline, up to 1129' MSL.

Trees beginning 1757' from DER, 746' left of centerline, up to 1138' MSL.

Trees beginning 1919' from DER, 129' left of centerline, up to 1142' MSL.

Trees beginning 1955' from DER, 357' left of centerline, up to 1144' MSL.

Trees beginning 2198' from DER, 84' left of centerline, up to 1145' MSL.

Tree 3008' from DER, 26' left of centerline, 1170' MSL.

22 FEB 2024 to 21 MAR 2024

22 FEB 2024 to 21 MAR 2024

TAKEOFF MINIMUMS, (OBSTACLE) DEPARTURE PROCEDURES, AND DIVERSE VECTOR AREA (RADAR VECTORS)

24025

TAKEOFF MINIMUMS, (OBSTACLE) DEPARTURE PROCEDURES, AND DIVERSE VECTOR AREA (RADAR VECTORS)

24025

BELLE FOURCHE, SD

BELLE FOURCHE MUNI (EFC)

TAKEOFF MINIMUMS AND (OBSTACLE) DEPARTURE PROCEDURES

AMDT 3 15JUN23 (23166) (FAA)

TAKEOFF MINIMUMS:

Rwys 18, 36, NA-Environmental.

Rwy 14, std. w/min. climb of 250' per NM to 9200 or 1900-3 for climb in visual conditions.

DEPARTURE PROCEDURE:

Rwy 32, climb on heading 321° to 3900 before proceeding southbound VCOA:

Rwy 14, obtain ATC approval for VCOA when requesting IFR clearance. Climb in visual conditions to cross Belle Fourche Muni airport at or above 4900 before proceeding on course.

TAKEOFF OBSTACLE NOTES:

Rwy 14, electrical system 9' from DER, 9' left of centerline, 9' AGL/3183' MSL.

Fences beginning 50' from DER, 487' left of centerline, up to 10' AGL/3188' MSL.

Fence 349' from DER, 434' left of centerline, 3' AGL/3190' MSL.

Fence 366' from DER, 423' left of centerline, 10' AGL/3196' MSL.

Rwy 32, electrical system 10' from DER, 10' left of centerline, 3' AGL/3172' MSL.

BEMIDJI, MN

BEMIDJI RGNL (BJI)

TAKEOFF MINIMUMS AND (OBSTACLE) DEPARTURE PROCEDURES

AMDT 3 31JUL08 (08213) (FAA)

TAKEOFF OBSTACLE NOTES:

Rwy 7, vegetation beginning 859' from DER, 544' right of centerline, up to 62' AGL/1442' MSL.

Vegetation beginning 1404' from DER, 683' left of centerline, up to 44' AGL/1424' MSL.

Rwy 13, vehicle on road, 541' from DER, 525' right of centerline, 15' AGL/1398' MSL.

Rwy 25, poles beginning 1337' from DER, 205' right of centerline up to 61' AGL/1445' MSL.

Trees beginning 1414' from DER, 254' left of centerline, up to 57' AGL/1441' MSL.

Tree 1406' from DER, 233' right of centerline, 53' AGL/1437' MSL.

BENSON, MN

BENSON MUNI (BBB)

TAKEOFF MINIMUMS AND (OBSTACLE) DEPARTURE PROCEDURES

AMDT 1 07MAY09 (09127) (FAA)

TAKEOFF OBSTACLE NOTES:

Rwy 14, numerous trees beginning 838' from DER, 246' right of centerline, up to 33' AGL/1087' MSL.

Numerous trees beginning 1232' from DER, 64' left of centerline, up to 69' AGL/1108' MSL.

Sign 206' from DER, 198' left of centerline, 19' AGL/1044' MSL.

Tower 4884' from DER, 274' right of centerline, 126' AGL/1161' MSL.

Rwy 32, Tree 2380' from DER, 646' left of centerline, 68' AGL/1107' MSL.

Multiple fences beginning 13' from DER, 361' left of centerline, up to 8' AGL/1043' MSL.

BIGFORK, MN

BIGFORK MUNI (FOZ)

TAKEOFF MINIMUMS AND (OBSTACLE) DEPARTURE PROCEDURES

AMDT 1 29MAR18 (18088) (FAA)

DEPARTURE PROCEDURE:

Rwy 15, climb on heading 149° to 1800 before turning right.

TAKEOFF OBSTACLE NOTES:

Rwy 15, sign 20' from DER, 115' left of centerline, 3' AGL/1348' MSL.

Tree 29' from DER, 326' right of centerline, 1354' MSL.

Trees beginning 63' from DER, 168' right of centerline, up to 1370' MSL.

Traverse way 67' from DER, 432' left of centerline, 1363' MSL.

Trees beginning 154' from DER, 393' left of centerline, up to 1378' MSL.

Trees beginning 189' from DER, 348' right of centerline, up to 1371' MSL.

Trees beginning 261' from DER, 413' left of centerline, up to 1379' MSL.

Tree 274' from DER, 292' right of centerline, 1374' MSL.

Tree 392' from DER, 556' left of centerline, 1387' MSL.

Trees beginning 393' from DER, 344' right of centerline, up to 1375' MSL.

Trees beginning 493' from DER, 177' right of centerline, up to 1396' MSL.

Tree 513' from DER, 604' left of centerline, 1417' MSL.

Trees beginning 556' from DER, 185' left of centerline, up to 1420' MSL.

Trees beginning 580' from DER, 272' right of centerline, up to 1403' MSL.

Tree 957' from DER, 679' right of centerline, 1407' MSL.

Trees beginning 996' from DER, 123' right of centerline, up to 1414' MSL.

Trees beginning 2109' from DER, 539' right of centerline, up to 1423' MSL.

Trees beginning 2698' from DER, 448' right of centerline, up to 1434' MSL.

Trees beginning 2800' from DER, 93' right of centerline, up to 1442' MSL.

Trees beginning 3374' from DER, 519' right of centerline, up to 1444' MSL.

CON'T

TAKEOFF MINIMUMS, (OBSTACLE) DEPARTURE PROCEDURES, AND DIVERSE VECTOR AREA (RADAR VECTORS)

24025

TAKEOFF MINIMUMS, (OBSTACLE) DEPARTURE PROCEDURES, AND DIVERSE VECTOR AREA (RADAR VECTORS)

24025

BIGFORK, MN (CON'T)

BIGFORK MUNI (FOZ) (CON'T)

Rwy 33, tree 56' from DER, 374' right of centerline, 1375' MSL.
 Trees beginning 81' from DER, 257' left of centerline, up to 1378' MSL.
 Trees beginning 82' from DER, 245' right of centerline, up to 1376' MSL.
 Trees beginning 178' from DER, 287' left of centerline, up to 1413' MSL.
 Trees beginning 503' from DER, 300' right of centerline, up to 1381' MSL.
 Trees beginning 543' from DER, 390' left of centerline, up to 1414' MSL.
 Trees beginning 720' from DER, 329' right of centerline, up to 1384' MSL.
 Trees beginning 757' from DER, 1' left of centerline, up to 1424' MSL.
 Trees beginning 1207' from DER, 73' right of centerline, up to 1396' MSL.
 Tree 1231' from DER, 63' right of centerline, 1399' MSL.
 Tree 1246' from DER, 142' right of centerline, 1401' MSL.
 Trees beginning 1249' from DER, 42' right of centerline, up to 1403' MSL.
 Tree 1354' from DER, 184' right of centerline, 1405' MSL.
 Tree 1378' from DER, 167' right of centerline, 1406' MSL.
 Trees beginning 1397' from DER, 149' right of centerline, up to 1410' MSL.
 Trees beginning 1609' from DER, 254' right of centerline, up to 1418' MSL.
 Trees beginning 1746' from DER, 1' right of centerline, up to 1426' MSL.
 Trees beginning 2435' from DER, 8' right of centerline, up to 1429' MSL.
 Trees beginning 2566' from DER, 7' right of centerline, up to 1430' MSL.
 Tree 2777' from DER, 596' left of centerline, 1425' MSL.

BISMARCK, ND

BISMARCK MUNI (BIS)

TAKEOFF MINIMUMS AND (OBSTACLE) DEPARTURE PROCEDURES

AMDT 8 10MAR11 (11069) (FAA)

DEPARTURE PROCEDURE:

Rwy 13, climb heading 131° to 2400 before turning right.

Rwy 21, climb heading 212° to 3700 before turning left.

Rwy 31, climb heading 311° to 2200 before turning right.

TAKEOFF OBSTACLE NOTES:

Rwy 13, trees and pole beginning 864' from DER, 721' left of centerline, up to 56' AGL/1696' MSL.

Rwy 31, light pole 1424' from DER, 872' right of centerline, 43' AGL/1702' MSL.

BLUE EARTH, MN

BLUE EARTH MUNI (SBU)

TAKEOFF MINIMUMS AND (OBSTACLE) DEPARTURE PROCEDURES

ORIG 31MAR16 (16091) (FAA)

TAKEOFF MINIMUMS:

Rwy 3, 21, NA-Environmental.

TAKEOFF OBSTACLE NOTES:

Rwy 16, poles beginning 1017' from DER, 586' left of centerline, up to 32' AGL/1142' MSL.

Rwy 34, trees beginning 3407' from DER, 523' right of centerline, up to 100' AGL/1200' MSL.

BOTTINEAU, ND

BOTTINEAU MUNI (D09)

TAKEOFF MINIMUMS AND (OBSTACLE) DEPARTURE PROCEDURES

AMDT 1 03JUN10 (10154) (FAA)

TAKEOFF MINIMUMS:

Rwys 3, 21, NA.

DEPARTURE PROCEDURE:

Rwy 13, climb heading 127° to 2200 before turning left.

Rwy 31, climb heading 307° to 2600 before turning right.

TAKEOFF OBSTACLE NOTES:

Rwy 31, street light 116' from DER, 474' left of centerline, 16' AGL/1700' MSL.

BOWMAN, ND

BOWMAN RGNL (BWW)

TAKEOFF MINIMUMS AND (OBSTACLE) DEPARTURE PROCEDURES

ORIG 31MAR16 (16091) (FAA)

TAKEOFF OBSTACLE NOTES:

Rwy 13, terrain beginning 171' from DER, 334' right of centerline, 3013' MSL.

Terrain 4199' from DER, 1275' left of centerline, 3077' MSL.

Rwy 31, terrain beginning 18' from DER, 182' left of centerline, 2958' MSL.

Pole 2360' from DER, 395' right of centerline, 33' AGL/3005' MSL.

TAKEOFF MINIMUMS, (OBSTACLE) DEPARTURE PROCEDURES, AND DIVERSE VECTOR AREA (RADAR VECTORS)

24025

NC-1

TAKEOFF MINIMUMS, (OBSTACLE) DEPARTURE PROCEDURES, AND DIVERSE VECTOR AREA (RADAR VECTORS)

24025

BRAINERD, MN

BRAINERD LAKES RGNL (BRD)

TAKEOFF MINIMUMS AND (OBSTACLE) DEPARTURE PROCEDURES

AMDT 6 15NOV12 (12320) (FAA)

TAKEOFF OBSTACLE NOTES:

Rwy 16, multiple trees beginning 1830' from DER, 749' left of centerline, up to 74' AGL/1314' MSL.

Rwy 23, multiple trees beginning 1485' from DER, 91' left of centerline, up to 50' AGL/1299' MSL.

Tree 2426' from DER, 184' right of centerline, 50' AGL/1297' MSL.

Rwy 34, trees beginning 1635' from DER, left and right of centerline, up to 86' AGL/1312' MSL.

BRITTON, SD

BRITTON MUNI (BTN)

TAKEOFF MINIMUMS AND (OBSTACLE) DEPARTURE PROCEDURES

AMDT 3 10JAN13 (13010) (FAA)

TAKEOFF MINIMUMS:

Rwys 1, 19, NA-Environmental.

TAKEOFF OBSTACLE NOTES:

Rwy 13, trees, poles and terrain beginning 382' from DER, 9' right of centerline, up to 81' AGL/1439' MSL.

Trees, poles, vehicles on road and terrain beginning 1286' from DER, 17' left of centerline, up to 75' AGL/1449' MSL.

Rwy 31, trees and vehicles on road beginning 578' from DER, 185' right of centerline, up to 66' AGL/1375' MSL.

Tree and vehicles on road beginning 234' from DER, 413' left of centerline, up to 61' AGL/1370' MSL.

BROOKINGS, SD

BROOKINGS RGNL (BKX)

TAKEOFF MINIMUMS AND (OBSTACLE) DEPARTURE PROCEDURES

AMDT 2 25JUN15 (15176) (FAA)

TAKEOFF OBSTACLE NOTES:

Rwy 12, building 1297' from DER, 734' right of centerline, 38' AGL/1681' MSL.

Rwy 17, trees beginning 1219' from DER, 562' left of centerline, up to 82' AGL/1733' MSL.

Trees beginning 2097' from DER, 252' left of centerline, up to 82' AGL/1728' MSL.

Rwy 35, trees beginning 481' from DER, 407' right of centerline, up to 45' AGL/1641' MSL.

Railroad beginning 514' from DER, crossing centerline from right to left, 23' AGL/1626' MSL.

Trees 701' from DER, 216' left of centerline, 35' AGL/1631' MSL.

BUFFALO, MN

BUFFALO MUNI (CFE)

TAKEOFF MINIMUMS AND (OBSTACLE) DEPARTURE PROCEDURES

ORIG 13JAN11 (11013) (FAA)

TAKEOFF MINIMUMS:

Rwy 18, 300-1½ or std. w/min climb of 403' per NM to 1200.

TAKEOFF OBSTACLE NOTES:

Rwy 18, building 613' from DER, 608' right of centerline, up to 25' AGL/984' MSL.

Vehicle on road 710' from DER, 641' right of centerline, up to 17' AGL/986' MSL.

Trees beginning 1000' from DER, 615' left of centerline, up to 100' AGL/1059' MSL.

Rwy 36, building 361' from DER, 262' left of centerline, up to 25' AGL/994' MSL.

Vehicle on road 845' from DER, 701' left of centerline, up to 15' AGL/994' MSL.

Trees beginning 1506' from DER, 350' right of centerline, up to 100' AGL/1089' MSL.

Trees beginning 1508' from DER, 129' left of centerline, up to 100' AGL/1109' MSL.

CALEDONIA, MN

HOUSTON COUNTY (CHU)

TAKEOFF MINIMUMS AND (OBSTACLE) DEPARTURE PROCEDURES

ORIG 07OCT21 (21280) (FAA)

TAKEOFF MINIMUMS:

Rwy 31, 300-1½ or std. w/min. climb of 250' per NM to 1500.

TAKEOFF OBSTACLE NOTES:

Rwy 13, tractor, 310' from DER, crossing extended runway centerline, 15' AGL/1190' MSL.

Poles beginning 676' from DER, 209' right of centerline, up to 80' AGL/1240' MSL.

Poles beginning 1072' from DER, 6' left of centerline, up to 80' AGL/1240' MSL.

Rwy 31, bldg 70' from DER, 290' left of centerline, 55' AGL/1230' MSL.

Trees, poles beginning 258' from DER, 220' left of centerline, up to 100' AGL/1279' MSL.

Tractor 414' from DER, crossing extended runway centerline, 15' AGL/1190' MSL.

Poles beginning 474' from DER, 252' right of centerline, up to 80' AGL/1235' MSL.

Trees beginning 1846' from DER, 500' right of centerline, up to 100' AGL/1279' MSL.

Tree 5785' from DER, 1638' left of centerline, 100' AGL/1340' MSL.

Tree 1 NM from DER, 2102' left of centerline, 100' AGL/1379' MSL.

TAKEOFF MINIMUMS, (OBSTACLE) DEPARTURE PROCEDURES, AND DIVERSE VECTOR AREA (RADAR VECTORS)

24025

TAKEOFF MINIMUMS, (OBSTACLE) DEPARTURE PROCEDURES, AND DIVERSE VECTOR AREA (RADAR VECTORS)

24025

CAMBRIDGE, MN

CAMBRIDGE MUNI (CBG)

TAKEOFF MINIMUMS AND (OBSTACLE) DEPARTURE PROCEDURES

ORIG 05APR12 (12096) (FAA)

TAKEOFF OBSTACLE NOTES:

Rwy 16, navaid 38' from DER, 78' left of centerline, 2' AGL/941' MSL.

Poles beginning 1203' from DER, 140' left of centerline, up to 66' AGL/1007' MSL.

Navaid 40' from DER 81' right of centerline, 2' AGL/941' MSL.

Trees beginning 198' from DER, 8' left and right of centerline, up to 100' AGL/1011' MSL.

Fence post 176' from DER, 403' right of centerline, 8' AGL/947' MSL.

Vehicles on road 191' from DER, 431' right of centerline, 15' AGL/954' MSL.

Rwy 34, terrain beginning 167' from DER, 374' left of centerline, up to 951' MSL.

Fence post 178' from DER, 481' left of centerline, 14' AGL/959' MSL.

Fence 615' from DER, 329' left of centerline, 13' AGL/958' MSL.

Vehicles on road 12' from DER, 492' left and right of centerline, 15' AGL/969' MSL.

Trees beginning 498' from DER, 12' left and right of centerline, up to 100' AGL/1 020' MSL.

Building 427' from DER, 538' right of centerline, 24' AGL/969' MSL.

CANBY, MN

MYERS FLD (CNB)

TAKEOFF MINIMUMS AND (OBSTACLE) DEPARTURE PROCEDURES

AMDT 1 29JUL10 (21280) (FAA)

TAKEOFF OBSTACLE NOTES:

Rwy 12, numerous poles beginning 40' from DER, 421' left and right of centerline, up to 36' AGL/1216' MSL.

Truck on roads beginning 134' from DER, 37' left and right of centerline, up to 22' AGL/1202' MSL.

Tree 3' from DER, 159' right of centerline, 7' AGL/1187' MSL.

Rwy 30, numerous trees beginning 726' from DER, 176' left of centerline, up to 70' AGL/1278' MSL.

Tree 1338' from DER, 716' right of centerline, 68' AGL/1268' MSL.

CANDO, ND

CANDO MUNI (9D7)

TAKEOFF MINIMUMS AND (OBSTACLE) DEPARTURE PROCEDURES

ORIG 20AUG15 (15232) (FAA)

TAKEOFF OBSTACLE NOTES:

Rwy 16, vehicles on road 443' from DER, 524' left of centerline, 15' AGL/1495' MSL.

Lt support structure 10' from DER, 10' right of centerline, 3' AGL/1484' MSL.

Rwy 34, poles beginning 382' from DER, 465' right of centerline, up to 32' AGL/1513' MSL.

Building 277' from DER, 574' right of centerline, 22' AGL/1503' MSL.

Vehicles on road beginning 596' from DER, 25' right of centerline, 15' AGL/1500' MSL.

Vehicles on road beginning 754' from DER, 16' left of centerline, 15' AGL/1504' MSL.

Lt support structure 10' from DER, 9' right of centerline, 3' AGL/1483' MSL.

Tank 344' from DER, 470' right of centerline, 9' AGL/1490' MSL.

CARRINGTON, ND

CARRINGTON MUNI (46D)

TAKEOFF MINIMUMS AND (OBSTACLE) DEPARTURE PROCEDURES

ORIG 27JUN13 (13178) (FAA)

TAKEOFF OBSTACLE NOTES:

Rwy 13, trees beginning 2097' from DER, 314' left of centerline, up to 100' AGL/1676' MSL.**Rwy 31**, terrain 60' from DER, 481' left of centerline, 1614' MSL.

Trees beginning 603' from DER, 341' left of centerline, up to 100' AGL/1709' MSL.

CASSELTON, ND

CASSELTON ROBERT MILLER RGNL (5N8)

TAKEOFF MINIMUMS AND (OBSTACLE) DEPARTURE PROCEDURES

ORIG 20DEC07 (07354) (FAA)

TAKEOFF MINIMUMS:

Rwy 31, 400-2½ or std. w/min. climb of 212' per NM to 1400 or alternatively, with std. takeoff minimums and a normal 200'/

NM climb gradient, takeoff must occur no later than 1700' prior to DER.

TAKEOFF OBSTACLE NOTES:

Rwy 13, railroad 30' from DER, 505' right of centerline, 23' AGL/945' MSL.

Vehicle on road 449' from DER, 300' left of centerline, 15' AGL/949' MSL.

Rwy 31, trees 2251' from DER, 456' left of centerline, up to 100' AGL/1052' MSL.

TAKEOFF MINIMUMS, (OBSTACLE) DEPARTURE PROCEDURES, AND DIVERSE VECTOR AREA (RADAR VECTORS)

24025

TAKEOFF MINIMUMS, (OBSTACLE) DEPARTURE PROCEDURES, AND DIVERSE VECTOR AREA (RADAR VECTORS)

24025

CAVALIER, ND

CAVALIER MUNI (2C8)

TAKEOFF MINIMUMS AND (OBSTACLE) DEPARTURE PROCEDURES

AMDT 1 20SEP12 (12264) (FAA)

TAKEOFF OBSTACLE NOTES:

Rwy 16, trees beginning 83' from DER, 454' left of centerline, up to 77' AGL/963' MSL.

Trees beginning 751' from DER, 615' right of centerline, up to 77' AGL/963' MSL.

Power pole 1233' from DER, 544' right of centerline, 38' AGL/927' MSL.

Power poles beginning 1445' from DER, 330' left of centerline, up to 45' AGL/931' MSL.

Bean elevator 1603' from DER, 450' left of centerline, 83' AGL/1003' MSL.

Tank 1736' from DER, 434' left of centerline, 83' AGL/969' MSL.

Rwy 34, trees beginning 1053' from DER, 623' left of centerline, up to 65' AGL/959' MSL.

Trees beginning 2005' from DER, 393' right of centerline, up to 65' AGL/954' MSL.

CHAMBERLAIN, SD

CHAMBERLAIN MUNI (9V9)

TAKEOFF MINIMUMS AND (OBSTACLE) DEPARTURE PROCEDURES

AMDT 1 13DEC12 (12348) (FAA)

TAKEOFF MINIMUMS:

Rwys 18,36, NA-Environmental.

TAKEOFF OBSTACLE NOTES:

Rwy 13, trees left and right of centerline beginning 100' from DER, up to 47' AGL/1725' MSL.

Pole 1116' from DER, 712' left of centerline, 32' AGL/1710' MSL.

Rwy 31, rising terrain 91' from DER, 290' right of centerline, 1702' MSL.

Vehicle on road 1072' from DER, from 553' to 781' right of centerline, 15' AGL/1728' MSL.

Trees left and right of centerline beginning 1359' from DER, up to 71' AGL/1767' MSL.

Pole 1201' from DER, 701' right of centerline, 45' AGL/1741' MSL.

CLARK, SD

CLARK COUNTY (8D7)

TAKEOFF MINIMUMS AND (OBSTACLE) DEPARTURE PROCEDURES

ORIG 17AUG17 (17229) (FAA)

TAKEOFF MINIMUMS:

Rwys 3, 21, NA-Environmental.

Rwy 31, std. w/min climb of 207' per NM to 2500 or 1800-3 for VCOA or alternatively, with std. takeoff minimums and a normal 200' per NM climb gradient, takeoff must occur no later than 1600' prior to DER.

DEPARTURE PROCEDURES:

Rwy 13, climb on heading 131° to 2900 before turning northeast.

Rwy 31, climb on heading 311° to 2600 before proceeding on course.

VCOA:

Rwy 31, obtain ATC approval for VCOA when requesting IFR clearance. Climb in visual conditions to cross Clark County airport at or above 3400 before proceeding on course.

TAKEOFF OBSTACLE NOTES:

Rwy 13, fence 4' from DER, 346' right of centerline, 1791' MSL.

Tree 63' from DER, 475' right of centerline, 1796' MSL.

Tree 83' from DER, 262' left of centerline, 1797' MSL.

Tree 130' from DER, 425' left of centerline, 1800' MSL.

Tree 277' from DER, 522' left of centerline, 1807' MSL.

Tree 2500' from DER, 1100' left of centerline, 1898' MSL.

Trees and pole beginning 2675' from DER, 320' left of centerline, up to 1908' MSL.

Rwy 31, tree 268' from DER, 560' left of centerline, 1817' MSL.

Vehicle on road beginning 416' from DER, 155' left of centerline, up to 1812' MSL.

Tree 1407' from DER, 676' right of centerline, 1842' MSL.

22 FEB 2024 to 21 MAR 2024

22 FEB 2024 to 21 MAR 2024

TAKEOFF MINIMUMS, (OBSTACLE) DEPARTURE PROCEDURES, AND DIVERSE VECTOR AREA (RADAR VECTORS)

24025

NC-1

TAKEOFF MINIMUMS, (OBSTACLE) DEPARTURE PROCEDURES, AND DIVERSE VECTOR AREA (RADAR VECTORS)

24025

CLOQUET, MN

CLOQUET/CARLTON COUNTY (COQ)

TAKEOFF MINIMUMS AND (OBSTACLE) DEPARTURE PROCEDURES

AMDT 3 10SEP20 (22139) (FAA)

TAKEOFF OBSTACLE NOTES:

Rwy 7, trees beginning abeam DER, 264' left of centerline, up to 100' AGL/1369' MSL.

Trees beginning 897' from DER, 358' right of centerline, up to 100' AGL/1349' MSL.

Vehicles on road beginning abeam, 431' right of centerline, 15' AGL/1274' MSL.

Rwy 18, electrical system 30' from DER, 109' left of centerline, 14' AGL/1273' MSL.

Trees beginning 68' from DER, 371' right of centerline, up to 1302' MSL.

Trees beginning 325' from DER, 511' right of centerline, up to 1340' MSL.

Rwy 25, trees beginning 152' from DER, 446' right of centerline, up to 1310' MSL.

Tree 541' from DER, 365' left of centerline, 1313' MSL.

Trees beginning 826' from DER, 479' right of centerline, up to 1323' MSL.

Trees beginning 1190' from DER, 505' right of centerline, up to 1362' MSL.

Trees beginning 1624' from DER, 461' left of centerline, up to 1359' MSL.

Trees beginning 1845' from DER, 741' left of centerline, up to 1365' MSL.

Tree 2003' from DER, 539' left of centerline, 1378' MSL.

Trees beginning 2127' from DER, 476' left of centerline, up to 1388' MSL.

Rwy 36, tree 40' from DER, 433' left of centerline, 1318' MSL.

Trees beginning 2267' from DER, 9' left of centerline, up to 1337' MSL.

Tree 2677' from DER, 10' right of centerline, 1346' MSL.

Tree 2765' from DER, 103' right of centerline, 1360' MSL.

Trees beginning 2767' from DER, 10' right of centerline, up to 1366' MSL.

COOK, MN

COOK MUNI (CQM)

TAKEOFF MINIMUMS AND (OBSTACLE) DEPARTURE PROCEDURES

AMDT 1 09FEB12 (12040) (FAA)

TAKEOFF OBSTACLE NOTES:

Rwy 13, trees and terrain beginning 17' from DER, left and right of centerline, up to 60' AGL/1379' MSL.

Buildings beginning 326' from DER, 561' left of centerline, up to 20' AGL/1349' MSL.

Rwy 31, trees beginning 134' from DER, 376' left and right of centerline, up to 60' AGL/1389' MSL.

COOPERSTOWN, ND

COOPERSTOWN MUNI (S32)

TAKEOFF MINIMUMS AND (OBSTACLE) DEPARTURE PROCEDURES

ORIG 18NOV10 (10322) (FAA)

TAKEOFF OBSTACLE NOTES:

Rwy 13, power lines 4085' from DER, 1585' right to 1588' left of centerline, up to 80' AGL/1526' MSL.

Rwy 31, building 12' from DER, 369' left of centerline, 14' AGL/1443' MSL.

Vehicles 312' from DER, 550' left of centerline, 15' AGL/1444' MSL.

Vehicles 353' from DER, 585' right of centerline, 15' AGL/1434' MSL.

CROOKSTON, MN

CROOKSTON MUNI/KIRKWOOD FLD (CKN)

TAKEOFF MINIMUMS AND (OBSTACLE) DEPARTURE PROCEDURES

AMDT 2 25OCT07 (21336) (FAA)

TAKEOFF MINIMUMS:

Rwys 6, 17, 24, 35, NA-Turf runways.

TAKEOFF OBSTACLE NOTES:

Rwy 13, tree 1998' from DER, 587' left of centerline, 94' AGL/970' MSL.

Pole 1127' from DER, 662' left of centerline, 46' AGL/926' MSL.

CROSBY, ND

CROSBY MUNI (D50)

TAKEOFF MINIMUMS AND (OBSTACLE) DEPARTURE PROCEDURES

ORIG 03JUN10 (10154) (FAA)

TAKEOFF MINIMUMS:

Rwys 3, 21, NA-Environmental.

TAKEOFF OBSTACLE NOTES:

Rwy 12, hangars and poles beginning 133' from DER, 263' right of centerline, up to 35' AGL/1983' MSL.

Vehicle on road 800' from DER, 200' right of centerline, 22' AGL/1967' MSL.

Rwy 30, power line, 2100' from DER, on centerline, 60' AGL/2011' MSL.

TAKEOFF MINIMUMS, (OBSTACLE) DEPARTURE PROCEDURES, AND DIVERSE VECTOR AREA (RADAR VECTORS)

24025

TAKEOFF MINIMUMS, (OBSTACLE) DEPARTURE PROCEDURES, AND DIVERSE VECTOR AREA (RADAR VECTORS)

24025

DETROIT LAKES, MN

DETROIT LAKES/WETHING FLD (DTL)

TAKEOFF MINIMUMS AND (OBSTACLE) DEPARTURE PROCEDURES

AMDT 1 25FEB21 (21336) (FAA)

TAKEOFF MINIMUMS:

Rwys 18, 36, NA-Environmental.

DEPARTURE PROCEDURE:

Rwy 14, climb on heading 138° to 1900 before proceeding on course.

TAKEOFF OBSTACLE NOTES:

Rwy 14, lighting 5' from DER, 112' left of centerline, 3' AGL/1363' MSL.

Lighting 6' from DER, 113' right of centerline, 3' AGL/1364' MSL.

Tree 28' from DER, 377' right of centerline, 1366' MSL.

Tree, pole, beginning 50' from DER, 3' right of centerline, up to 62' AGL/1428' MSL.

Vehicle on road 195' from DER, 509' left of centerline, 1377' MSL.

Vehicle on road, beginning 397' from DER, 498' left of centerline, up to 1378' MSL.

Trees, beginning 964' from DER, 449' left of centerline, up to 1392' MSL.

Tree 1216' from DER, 175' left of centerline, 1399' MSL.

Trees, beginning 1440' from DER, 194' left of centerline, up to 1420' MSL.

Rwy 32, vehicle on road, lighting beginning 1' from DER, 112' left of centerline, up to 1415' MSL.

Lighting 5' from DER, 112' right of centerline, 3' AGL/1399' MSL.

Vehicle on road beginning 18' from DER, 215' right of centerline, up to 1407' MSL.

Building 378' from DER, 514' left of centerline, 27' AGL/1417' MSL.

Pole, building beginning 390' from DER, 317' left of centerline, up to 29' AGL/1420' MSL.

Tree 1166' from DER, 797' left of centerline, 53' AGL/1427' MSL.

DEVILS LAKE, ND

DEVILS LAKE RGNL (DVL)

TAKEOFF MINIMUMS AND (OBSTACLE) DEPARTURE PROCEDURES

AMDT 2 12DEC13 (13346) (FAA)

DEPARTURE PROCEDURE:

Rwy 3, Climb heading 038° to 1900 before turning left.

TAKEOFF OBSTACLE NOTES:

Rwy 3, tree 1523' from DER, 136' right of centerline, 49' AGL/1489' MSL.

Tree 1531' from DER, 319' left of centerline, 50' AGL/1490' MSL.

Trees beginning 3105' from DER, 544' right of centerline, 71' AGL/1522' MSL.

Rwy 13, tree 1144' from DER, 716' right of centerline, 37' AGL/1482' MSL.

Pole 1601' from DER, 609' right of centerline, 39' AGL/1484' MSL.

Rwy 21, vehicle on road beginning 335' from DER, 404' right of centerline, up to 15' AGL/1477' MSL.

Antenna on pole 552' from DER, 595' left of centerline, 61' AGL/1506' MSL.

Trees beginning 613' from DER, 355' left of centerline, up to 47' AGL/1492' MSL.

Vehicles on road beginning 674' from DER, left and right of centerline, up to 15' AGL/1483' MSL.

Transmission tower 3566' from DER, 441' left of centerline, 123' AGL/1549' MSL.

DICKINSON, ND

DICKINSON/THEODORE ROOSEVELT RGNL (DIK)

TAKEOFF MINIMUMS AND (OBSTACLE) DEPARTURE PROCEDURES

AMDT 3 03NOV22 (22307) (FAA)

DEPARTURE PROCEDURE:

Rwy 25, climb on heading 250° to 3500 before turning left.

TAKEOFF OBSTACLE NOTES:

Rwy 7, lighting 9' from DER, 26' left of centerline, 3' AGL/2594' MSL.

Lighting 10' from DER, 28' right of centerline, 3' AGL/2594' MSL.

Lighting 128' from DER, 113' left of centerline, 4' AGL/2596' MSL.

Vehicle on road beginning 822' from DER, 55' right of centerline, up to 2620' MSL.

Vehicle on road beginning 875' from DER, 45' left of centerline, up to 2619' MSL.

Rwy 14, terrain beginning 5' from DER, 52' left of centerline, up to 2584' MSL.

Terrain 6' from DER, 53' right of centerline, 2584' MSL.

Terrain beginning 14' from DER, 191' left of centerline, up to 2585' MSL.

Lighting 73' from DER, 100' right of centerline, 4' AGL/2587' MSL.

Terrain beginning 86' from DER, 225' left of centerline, up to 2586' MSL.

Terrain 187' from DER, 306' left of centerline, 2587' MSL.

NAVAID 253' from DER, 117' right of centerline, 7' AGL/2589' MSL.

Rwy 25, lighting 10' from DER, 94' right of centerline, 3' AGL/2572' MSL.

Lighting 40' from DER, 113' left of centerline, 4' AGL/2574' MSL.

Lighting 40' from DER, 113' right of centerline, 4' AGL/2574' MSL.

Fence 193' from DER, 349' left of centerline, 10' AGL/2581' MSL.

Terrain 642' from DER, 566' left of centerline, 2589' MSL.

Terrain 758' from DER, 670' left of centerline, 2595' MSL.

Fence 922' from DER, 349' left of centerline, 11' AGL/2603' MSL.

22 FEB 2024 to 21 MAR 2024

22 FEB 2024 to 21 MAR 2024

TAKEOFF MINIMUMS, (OBSTACLE) DEPARTURE PROCEDURES, AND DIVERSE VECTOR AREA (RADAR VECTORS)

24025

NC-1

**TAKEOFF MINIMUMS, (OBSTACLE) DEPARTURE PROCEDURES, AND
DIVERSE VECTOR AREA (RADAR VECTORS)**

24025

DODGE CENTER, MN**DODGE CENTER (TOB)**

TAKEOFF MINIMUMS AND (OBSTACLE) DEPARTURE PROCEDURES

ORIG 15JAN09 (09015) (FAA)

TAKEOFF MINIMUMS:

Rwy 22, NA-Environmental.

TAKEOFF OBSTACLE NOTES:

Rwy 16, trees 3945' from DER, 1542' left of centerline, 100' AGL/1409' MSL.**DULUTH, MN****DULUTH INTL (DLH)**

TAKEOFF MINIMUMS AND (OBSTACLE) DEPARTURE PROCEDURES

AMDT 1 10OCT19 (19283) (FAA)

TAKEOFF OBSTACLE NOTES:

Rwy 3, tree 5' from DER, 306' right of centerline, 12' AGL/1424' MSL.

Trees, terrain beginning 11' from DER, 300' right of centerline, up to 1442' MSL.

Tree 234' from DER, 542' right of centerline, 1464' MSL.

Tree 612' from DER, 26' left of centerline, 1432' MSL.

Trees beginning 655' from DER, 441' right of centerline, up to 1471' MSL.

Tree 1217' from DER, 789' left of centerline, 1449' MSL.

Trees beginning 1469' from DER, 596' left of centerline, up to 54' AGL/1468' MSL.

Trees beginning 1501' from DER, 519' right of centerline, up to 1478' MSL.

Tree 1600' from DER, 704' right of centerline, 1481' MSL.

Trees beginning 1673' from DER, 225' right of centerline, up to 1484' MSL.

Trees beginning 1892' from DER, 622' left of centerline, up to 59' AGL/1476' MSL.

Trees beginning 2112' from DER, 598' left of centerline, up to 60' AGL/1479' MSL.

Trees beginning 2171' from DER, 532' left of centerline, up to 64' AGL/1482' MSL.

Rwy 21, sign 30' from DER, 399' right of centerline, 3' AGL/1416' MSL.

Vehicles on road 178' from DER, 412' right of centerline, 1426' MSL.

Vehicles on road 359' from DER, 423' right of centerline, 1429' MSL.

Tree 471' from DER, 563' left of centerline, 37' AGL/1440' MSL.

Tree, vehicles on road, poles, transmission line beginning 576' from DER, 423' right of centerline, up to 1457' MSL.

Trees beginning 1183' from DER, 778' left of centerline, up to 44' AGL/1460' MSL.

Tower 3751' from DER, 408' left of centerline, 92' AGL/1522' MSL.

Rwy 27, lighting beginning 4' from DER, 80' left of centerline, up to 2' AGL/1428' MSL.

Lighting 4' from DER, 120' right of centerline, 2' AGL/1428' MSL.

Lighting beginning 4' from DER, 20' right of centerline, up to 2' AGL/1429' MSL.

Lighting beginning 4' from DER, 29' left of centerline, up to 2' AGL/1429' MSL.

Lighting 99' from DER, 6' left of centerline, 3' AGL/1431' MSL.

Vegetation 347' from DER, 484' left of centerline, 1437' MSL.

Trees beginning 1190' from DER, 791' left of centerline, up to 1470' MSL.

Tree 1606' from DER, 558' right of centerline, 33' AGL/1468' MSL.

Trees beginning 1829' from DER, 961' right of centerline, up to 60' AGL/1505' MSL.

Trees beginning 2137' from DER, 989' right of centerline, up to 1507' MSL.

Trees beginning 2257' from DER, 997' left of centerline, up to 36' AGL/1509' MSL.

Trees beginning 2390' from DER, 986' left of centerline, up to 1519' MSL.

Trees beginning 2425' from DER, 985' right of centerline, up to 1522' MSL.

Trees beginning 2561' from DER, 326' left of centerline, up to 1524' MSL.

Trees beginning 2573' from DER, 1065' right of centerline, up to 1528' MSL.

Trees beginning 2651' from DER, 389' right of centerline, up to 1531' MSL.

Trees beginning 2903' from DER, 981' right of centerline, up to 1534' MSL.

Trees beginning 2960' from DER, 306' right of centerline, up to 1541' MSL.

Trees beginning 3117' from DER, 531' left of centerline, up to 1533' MSL.

Trees beginning 3142' from DER, 412' left of centerline, up to 52' AGL/1539' MSL.

22 FEB 2024 to 21 MAR 2024

22 FEB 2024 to 21 MAR 2024

**TAKEOFF MINIMUMS, (OBSTACLE) DEPARTURE PROCEDURES, AND
DIVERSE VECTOR AREA (RADAR VECTORS)**

24025

TAKEOFF MINIMUMS, (OBSTACLE) DEPARTURE PROCEDURES, AND DIVERSE VECTOR AREA (RADAR VECTORS)

24025

DULUTH, MN (CON'T)

SKY HARBOR (DYT)

TAKEOFF MINIMUMS AND (OBSTACLE) DEPARTURE PROCEDURES

ORIG 29DEC22 (22363) (FAA)

TAKEOFF MINIMUMS:

Rwys 13W, 31W, 9W, 27W, NA-Environmental.

Rwy 32, std. w/min. climb of 230' per NM to 1900.

DEPARTURE PROCEDURE:

Rwy 14, climb heading 144° to 1300 before proceeding on course.

Rwy 32, climb on a heading between 142° CW to 270° from DER.

TAKEOFF OBSTACLE NOTES:

Rwy 14, traverse way 3' from DER, 378' left of centerline, 610' MSL.

Traverse way 52' from DER, 433' left of centerline, 622' MSL.

Pole, tree, boat 63' from DER, 4' left of centerline, up to 481' left of centerline, up to 75' AGL/683' MSL.

Trees, traverse way beginning 239' from DER, 452' left of centerline, up to 75' AGL/684' MSL.

Trees, traverse way, pole beginning 304' from DER, 460' left of centerline, up to 685' MSL.

Trees, pole beginning 616' from DER, 454' left of centerline, up to 80' AGL/688' MSL.

Trees beginning 1717' from DER, 557' left of centerline, up to 79' AGL/690' MSL.

Trees beginning 1883' from DER, 570' left of centerline, up to 691' MSL.

Tree 1958' from DER, 728' left of centerline, 84' AGL/698' MSL.

Trees beginning 1988' from DER, 467' left of centerline, up to 83' AGL/699' MSL.

Rwy 32, pole, wind indicator beginning 87' from DER, 264' right of centerline, up to 17' AGL/625' MSL.

Building 140' from DER, 518' right of centerline, 28' AGL/633' MSL.

Tree 492' from DER, 593' right of centerline, 32' AGL/638' MSL.

Tree 531' from DER, 513' right of centerline, 36' AGL/640' MSL.

Boat 949' from DER, 330' left of centerline, 35' AGL/639' MSL.

Tree 3080' from DER, 533' right of centerline, 81' AGL/686' MSL.

EAGLE BUTTE, SD

CHEYENNE EAGLE BUTTE (84D)

TAKEOFF MINIMUMS AND (OBSTACLE) DEPARTURE PROCEDURES

AMD'T 1 27JAN22 (22027) (FAA)

DEPARTURE PROCEDURE:

Rwy 31, climb on heading 306° to 2900 before proceeding on course.

TAKEOFF OBSTACLE NOTES:

Rwy 13, fence 14' from DER, 347' left of centerline, 13' AGL/2455' MSL.

Fence 200' from DER, 347' left of centerline, 15' AGL/2457' MSL.

Fence 283' from DER, 347' left of centerline, 16' AGL/2458' MSL.

Rwy 31, fence 21' from DER, 390' right of centerline, 5' AGL/2433' MSL.

Terrain 27' from DER, 284' left of centerline, 2435' MSL.

Vehicle on road 70' from DER, 283' right of centerline, 2441' MSL.

Fence beginning 122' from DER, 364' left of centerline, up to 9' AGL/2441' MSL.

Vehicle on road beginning 138' from DER, 380' right of centerline, up to 2444' MSL.

EDGELEY, ND

EDGELEY MUNI (51D)

TAKEOFF MINIMUMS AND (OBSTACLE) DEPARTURE PROCEDURES

ORIG 13OCT16 (16287) (FAA)

TAKEOFF MINIMUMS:

Rwy 9, 27, NA-Turf strip.

TAKEOFF OBSTACLE NOTES:

Rwy 14, ground 5' from DER, 11' left of centerline, 1592' MSL.

Electric sys 11' from DER, 10' right of centerline, 2' AGL/1594' MSL.

Electric sys 11' from DER, 9' left of centerline, 2' AGL/1594' MSL.

Rwy 32, electric system 8' from DER, 10' left of centerline, 3' AGL/1603' MSL.

Fence 47' from DER, 250' left of centerline, 4' AGL/1604' MSL.

Pole 759' from DER, 672' right of centerline, 26' AGL/1626' MSL.

Tree 1276' from DER, 635' left of centerline, 47' AGL/1652' MSL.

Tree 1383' from DER, 823' left of centerline, 51' AGL/1652' MSL.

Tree 2075' from DER, 800' left of centerline, 58' AGL/1659' MSL.

Tree 2477' from DER, 854' left of centerline, 68' AGL/1669' MSL.

ELBOW LAKE, MN

ELBOW LAKE MUNI/PRIDE OF THE PRAIRIE (Y63)

TAKEOFF MINIMUMS AND (OBSTACLE) DEPARTURE PROCEDURES

ORIG-A 11AUG22 (22223) (FAA)

TAKEOFF MINIMUMS:

Rwys 11W, 29W, NA-Environmental.

TAKEOFF OBSTACLE NOTES:

Rwy 14, trees, sign, and terrain beginning 128' from DER, 73' right of centerline, up to 29' AGL/1229' MSL.

Navaid and terrain beginning 28' from DER, 69' left of centerline, up to 10' AGL/1210' MSL.

Rwy 32, trees beginning 405' from DER, 190' left of centerline, up to 32' AGL/1232' MSL.

TAKEOFF MINIMUMS, (OBSTACLE) DEPARTURE PROCEDURES, AND DIVERSE VECTOR AREA (RADAR VECTORS)

24025

NC-1

TAKEOFF MINIMUMS, (OBSTACLE) DEPARTURE PROCEDURES, AND DIVERSE VECTOR AREA (RADAR VECTORS)

24025

ELLENDALE, ND

ELLENDALE MUNI (4E7)

TAKEOFF MINIMUMS AND (OBSTACLE) DEPARTURE PROCEDURES

ORIG 01FEB18 (18032) (FAA)

TAKEOFF MINIMUMS:

Rwys 17, 35, NA-Environmental.

TAKEOFF OBSTACLE NOTES:

Rwy 13, fence, pole, terrain beginning 10' from DER, 36' right of centerline, up to 6' AGL/1462' MSL.

Trees, terrain beginning 89' from DER, 206' right of centerline, up to 26' AGL/1481' MSL.

Tree 122' from DER, 179' left of centerline, 1461' MSL.

Tree 268' from DER, 442' right of centerline, 1482' MSL.

Tree 983' from DER, 740' left of centerline, 1481' MSL.

Trees beginning 994' from DER, 455' right of centerline, up to 1501' MSL.

Tree 1077' from DER, 658' left of centerline, 1487' MSL.

Trees beginning 1149' from DER, 509' left of centerline, up to 1500' MSL.

Trees, transmission line, pole, tower beginning 1367' from DER, 384' right of centerline, up to 1507' MSL.

Trees beginning 1468' from DER, 243' left of centerline, up to 1501' MSL.

Tree 1573' from DER, 456' left of centerline, 57' AGL/1502' MSL.

Rwy 31, tree 4' from DER, 405' left of centerline, 27' AGL/1481' MSL.

Pole 19' from DER, 35' right of centerline, 2' AGL/1458' MSL.

Trees beginning 87' from DER, 295' left of centerline, up to 32' AGL/1485' MSL.

Tree 1056' from DER, 692' right of centerline, 59' AGL/1512' MSL.

Trees beginning 1474' from DER, 76' right of centerline, up to 80' AGL/1530' MSL.

Trees beginning 1729' from DER, 39' right of centerline, up to 85' AGL/1536' MSL.

ELLSWORTH AFB (KRCA),

RAPID CITY, SD

TAKEOFF MINIMUMS AND (OBSTACLE) DEPARTURE PROCEDURES

AMD T 1 13NOV14 (14317)

TAKEOFF OBSTACLE NOTES:

Rwy 13, Terrain 3182' MSL, 1' from DER, 490' left of centerline.

Terrain 3182' MSL, inward of DER, 500' left of centerline.

Terrain 3182' MSL, 0' from DER, 500' left of centerline.

Tree 140' AGL/3289' MSL, 2405' from DER, 1044' left of centerline.

B1 tail 34' AGL/3208' MSL, 64' inward of DER, 582' right of centerline.

Rwy 31, Building 12' AGL/3311' MSL, 1804' from DER, 762' left of centerline.

ELY, MN

ELY MUNI (ELO)

TAKEOFF MINIMUMS AND (OBSTACLE) DEPARTURE PROCEDURES

AMD T 3 09FEB12 (12040) (FAA)

TAKEOFF OBSTACLE NOTES:

Rwy 12, rising terrain and trees beginning 148' from DER, 18' right of centerline, up to 53' AGL/1539' MSL.

Trees beginning 181' from DER, 247' left of centerline, up to 81' AGL/1542' MSL.

Rwy 30, trees beginning 61' from DER, 242' left of centerline, up to 73' AGL/1520' MSL.

Trees beginning 665' from DER, 652' right of centerline, up to 100' AGL/1551' MSL.

Pole 670' from DER, 529' right of centerline, 49' AGL/1460' MSL.

EVELETH, MN

EVELETH/VIRGINIA MUNI (EVM)

TAKEOFF MINIMUMS AND (OBSTACLE) DEPARTURE PROCEDURES

AMD T 3A 09NOV17 (22307) (FAA)

TAKEOFF MINIMUMS:

Rwys 14, 32, NA-Environmental.

DEPARTURE PROCEDURE:

Rwy 27, northwest departures (270-050) climb heading 274° to 2000 before proceeding on course.

TAKEOFF OBSTACLE NOTES:

Rwy 9, trees beginning 1842' from DER, crossing centerline left to right, up to 88' AGL/1455' MSL.

Trees and vehicle on road beginning 13' from DER, 188' right of centerline, up to 88' AGL/433' MSL.

Rwy 27, trees and poles beginning 989' from DER, crossing centerline left to right, up to 110' AGL/1502' MSL.

Trees and vehicle on road beginning 66' from DER, 285' left of centerline, up to 37' AGL/1416' MSL.

TAKEOFF MINIMUMS, (OBSTACLE) DEPARTURE PROCEDURES, AND DIVERSE VECTOR AREA (RADAR VECTORS)

24025

NC-1

TAKEOFF MINIMUMS, (OBSTACLE) DEPARTURE PROCEDURES, AND DIVERSE VECTOR AREA (RADAR VECTORS)

24025

FAIRMONT, MN

FAIRMONT MUNI (FRM)

TAKEOFF MINIMUMS AND (OBSTACLE) DEPARTURE PROCEDURES

AMDT 3 07MAY09 (09127) (FAA)

TAKEOFF OBSTACLE NOTES:

Rwy 2, trees beginning 2466' from DER, 1105' right of centerline, up to 100' AGL/1269' MSL.

Rwy 13, tree 2340' from DER, 1039' left of centerline, 100' AGL/1269' MSL.

Rwy 20, trees beginning 1640' from DER, 914' right of centerline, up to 100' AGL/1289' MSL.

Trees beginning 913' from DER, 449' left of centerline, up to 100' AGL/1299' MSL.

Rwy 31, trees beginning 954' from DER, 161' left of centerline, up to 100' AGL/1299' MSL.

Trees and road beginning 791' from DER, 339' right of centerline, up to 57' AGL/1226' MSL.

FARGO, ND

HECTOR INTL (FAR)

TAKEOFF MINIMUMS AND (OBSTACLE) DEPARTURE PROCEDURES

AMDT 4A 15DEC11 (11349) (FAA)

TAKEOFF MINIMUMS:

Rwys 13,31, NA.

TAKEOFF OBSTACLE NOTES:

Rwy 9, tree 1876' from DER 686' left of centerline, 53' AGL/952' MSL.

Tree 2620' from DER, 1100' right of centerline, 66' AGL/965' MSL.

Road and vehicle beginning 420' from DER, 601' right of centerline, up to 15' AGL/913' MSL.

Road and vehicle beginning 543' from DER, 619' left of centerline, up to 15' AGL/912' MSL.

Runway end lights beginning 41' from DER, left and right of centerline, up to 3' AGL/901' MSL.

Sign 39' from DER, 201' left of centerline, 2' AGL/900' MSL.

Multiple light poles beginning 1082' from DER, left and right of centerline, up to 27' AGL/927' MSL.

Rwy 18, road and vehicle 536' from DER, 19' right of centerline, 15' AGL/914' MSL.

Rwy 27, road and vehicle beginning 451' from DER, 479' right of centerline, up to 15' AGL/910' MSL.

Tree 2912' from DER, 944' left of centerline, 72' AGL/971' MSL.

Runway end lights 42' from DER, 126' right of centerline, 2' AGL/898' MSL.

Rwy 36, light support structure 11' from DER, 55' right of centerline, 1' AGL/901' MSL.

FARIBAULT, MN

FARIBAULT MUNI-LIZ WALL STROHFUS FLD (FBL)

TAKEOFF MINIMUMS AND (OBSTACLE) DEPARTURE PROCEDURES

AMDT 1 07DEC17 (21084) (FAA)

TAKEOFF MINIMUMS:

Rwys 1, 19, NA-Environmental.

TAKEOFF OBSTACLE NOTES:

Rwy 12, road beginning 27' from DER, 496' right of centerline, 1063' MSL.

Tree, road beginning 123' from DER, 369' right of centerline, up to 1069' MSL.

Tree, road beginning 270' from DER, 308' right of centerline, up to 1092' MSL.

Road 323' from DER, 401' left of centerline, 1062' MSL.

Tree 331' from DER, 490' right of centerline, 1096' MSL.

Tree, road beginning 366' from DER, 286' right of centerline, up to 1105' MSL.

Pole, road, building, stack beginning 371' from DER, 334' left of centerline, up to 42' AGL/1085' MSL.

Rwy 30, tree, NAVAID beginning 17' from DER, 111' left of centerline, up to 1099' MSL.

Tree 39' from DER, 260' left of centerline, 1104' MSL.

Tree, 68' from DER, 498' left of centerline, 1121' MSL.

Trees beginning 125' from DER, 61' left of centerline, up to 1127' MSL.

Tree 249' from DER, 334' right of centerline, 1081' MSL.

Tree 338' from DER, 425' right of centerline, 1085' MSL.

Tree 377' from DER, 550' right of centerline 1111' MSL.

Trees beginning 511' from DER, 364' right of centerline, up to 1115' MSL.

Tree 2368' from DER, 649' right of centerline, 1129' MSL.

Tree 2836' from DER, 1178' right of centerline, 1136' MSL.

Trees beginning 2921' from DER, 1148' right of centerline, up to 1146' MSL.

FERGUS FALLS, MN

FERGUS FALLS MUNI/EINAR MICKELSON FLD (FFM)

TAKEOFF MINIMUMS AND (OBSTACLE) DEPARTURE PROCEDURES

ORIG 27AUG09 (22027) (FAA)

TAKEOFF OBSTACLE NOTES:

Rwy 13, trees beginning 2612' from DER, 128' right of centerline, up to 100' AGL/1269' MSL.

Trees beginning 2514' from DER, 42' left of centerline, up to 100' AGL/1259' MSL.

Rwy 17, trees beginning 1100' from DER 663' right of centerline, up to 100' AGL/1269' MSL.

Road 222' from DER, 469' right of centerline, 15' AGL/1173' MSL.

Rwy 35, trees beginning 2156' from DER, 176' right of centerline, up to 100' AGL/1289' MSL.

TAKEOFF MINIMUMS, (OBSTACLE) DEPARTURE PROCEDURES, AND DIVERSE VECTOR AREA (RADAR VECTORS)

24025

NC-1

TAKEOFF MINIMUMS, (OBSTACLE) DEPARTURE PROCEDURES, AND DIVERSE VECTOR AREA (RADAR VECTORS)

24025

FERTILE, MN

FERTILE MUNI (D14)

TAKEOFF MINIMUMS AND (OBSTACLE) DEPARTURE PROCEDURES

ORIG 20APR23 (23110) (FAA)

TAKEOFF MINIMUMS:

Rwy 14, 400-2¼ or std. w/min. climb of 232' per NM to 1600.

TAKEOFF OBSTACLE NOTES:

Rwy 14, trees beginning 91' from DER, 7' left of centerline, up to 100' AGL/1252' MSL.

Trees beginning 98' from DER, 4' right of centerline, up to 100' AGL/1255' MSL.

Trees, tree beginning 949' from DER, 137' left of centerline, up to 100' AGL/1255' MSL.

Trees beginning 1433' from DER, 100' left of centerline, up to 100' AGL/1259' MSL.

Trees beginning 1441' from DER, 41' right of centerline, up to 100' AGL/1259' MSL.

Elevator, trees beginning 2622' from DER, 78' right of centerline, up to 1277' MSL.

Trees beginning 2776' from DER, 64' left of centerline, up to 100' AGL/1262' MSL.

Trees beginning 3752' from DER, 51' left of centerline, up to 100' AGL/1265' MSL.

Trees beginning 3998' from DER, 15' left of centerline, up to 100' AGL/1268' MSL.

Tower 1.9 NM from DER, 6' right of centerline, 311' AGL/1475' MSL.

Rwy 32, trees 82' from DER, 227' left of centerline, 100' AGL/1236' MSL.

Trees beginning 86' from DER, 118' right of centerline, up to 100' AGL/1239' MSL.

Trees beginning 203' from DER, 35' left of centerline, up to 100' AGL/1239' MSL.

Trees beginning 332' from DER, 130' right of centerline, up to 100' AGL/1242' MSL.

Trees beginning 577' from DER, 1' right of centerline, up to 100' AGL/1246' MSL.

Trees beginning 1062' from DER, 11' left of centerline, up to 100' AGL/1242' MSL.

Trees beginning 1924' from DER, 179' right of centerline, up to 100' AGL/1249' MSL.

Trees beginning 2045' from DER, 13' right of centerline, up to 100' AGL/1255' MSL.

Trees beginning 2170' from DER, 25' right of centerline, up to 100' AGL/1259' MSL.

FOSSTON, MN

FOSSTON MUNI/ANDERSON FLD (FSE)

TAKEOFF MINIMUMS AND (OBSTACLE) DEPARTURE PROCEDURES

AMDT 2A 08NOV18 (22251) (FAA)

TAKEOFF OBSTACLE NOTES:

Rwy 16, road 17' from DER, 114' left of centerline, 10' AGL/1289' MSL.

Road 27' from DER, 127' left of centerline, 10' AGL/1289' MSL.

Rwy 34, multiple trees and REIL beginning 39' from DER, 78' left of centerline, up to 56' AGL/1329' MSL.

Tree 192' from DER, 537' right of centerline, 13' AGL/1273' MSL.

GARRISON, ND

GARRISON MUNI (D05)

TAKEOFF MINIMUMS AND (OBSTACLE) DEPARTURE PROCEDURES

ORIG 13JAN11 (11013) (FAA)

TAKEOFF MINIMUMS:

Rwys 3, 21, NA-Environmental.

TAKEOFF OBSTACLE NOTES:

Rwy 13, trees 849' from DER, 190' left of centerline, up to 100' AGL/1989' MSL.

Grain silos 1588' from DER, 895' left of centerline, 100' AGL/1989' MSL.

Rwy 31, vehicles on roadway beginning 424' from DER, left and right of centerline, up to 15' AGL/1974' MSL.

Trees 538' from DER, 425' left of centerline, up to 100' AGL/2059' MSL.

GETTYSBURG, SD

GETTYSBURG MUNI (0D8)

TAKEOFF MINIMUMS AND (OBSTACLE) DEPARTURE PROCEDURES

AMDT 1 18JAN07 (07018) (FAA)

TAKEOFF OBSTACLE NOTES:

Rwy 4, multiple trees beginning 1011' from DER, 420' left of centerline, up to 60' AGL/2119' MSL.**Rwy 13**, multiple trees beginning 1897' from DER, 975' left of centerline, 60' AGL/2119' MSL.**Rwy 22**, multiple trees beginning 679' from DER, 117' left of centerline, up to 60' AGL/2109' MSL.

GLENCOE, MN

GLENCOE MUNI (GYL)

TAKEOFF MINIMUMS AND (OBSTACLE) DEPARTURE PROCEDURES

ORIG 12MAR09 (09071) (FAA)

TAKEOFF OBSTACLE NOTES:

Rwy 13, trees beginning 349' from DER, 257' right of centerline, up to 100' AGL/1099' MSL.

Trees beginning 1211' from DER, 314' left of centerline, up to 100' AGL/1109' MSL.

Terrain beginning 53' from DER, 166' left of centerline, up to 998' MSL.

Terrain beginning 286' from DER, 435' right of centerline, up to 1001' MSL.

Rwy 31, trees beginning 501' from DER, 530' right of centerline, up to 100' AGL/1099' MSL.

Tree 2577' from DER, 129' left of centerline, 100' AGL/1109' MSL.

TAKEOFF MINIMUMS, (OBSTACLE) DEPARTURE PROCEDURES, AND DIVERSE VECTOR AREA (RADAR VECTORS)

24025

TAKEOFF MINIMUMS, (OBSTACLE) DEPARTURE PROCEDURES, AND DIVERSE VECTOR AREA (RADAR VECTORS)

24025

GLENWOOD, MN

GLENWOOD MUNI (GHW)

TAKEOFF MINIMUMS AND (OBSTACLE) DEPARTURE PROCEDURES

AMDT 3 26AUG10 (10233) (FAA)

TAKEOFF MINIMUMS:

Rwys 5, 23 N/A Environmental.

TAKEOFF OBSTACLE NOTES:

Rwy 15, road beginning 278' from DER, 521' left of centerline, 15' AGL/1414' MSL.

Trees beginning 3257' from DER, 1239' right of centerline, up to 100' AGL/1489' MSL.

Terrain beginning 42' from DER, 448' left of centerline, 1378' MSL.

Rwy 33, trees beginning 1266' from DER, 174' left of centerline, up to 100' AGL/1499' MSL.

Power lines beginning 1259' from DER, 793' left of centerline, up to 50' AGL/1439' MSL.

GLEN ULLIN, ND

GLEN ULLIN RGNL (D57)

TAKEOFF MINIMUMS AND (OBSTACLE) DEPARTURE PROCEDURES

ORIG 08NOV18 (18312) (FAA)

TAKEOFF MINIMUMS:

Rwy 11, 300-1/4 or std. w/ min. climb of 205' per NM to 2300, or alternatively, with std. takeoff minimums and a normal 200' per NM climb gradient, takeoff must occur no later than 1200' prior to DER.

TAKEOFF OBSTACLE NOTES:

Rwy 11, lighting 10' from DER, 9' right of centerline, 2' AGL/2093' MSL.

Lighting 10' from DER, 9' left of centerline, 2' AGL/2093' MSL.

Tree 577' from DER, 235' left of centerline, 2106' MSL.

Trees beginning 660' from DER, 403' right of centerline, up to 2128' MSL.

Trees beginning 793' from DER, 158' right of centerline, up to 2129' MSL.

Trees beginning 830' from DER, 352' left of centerline, up to 2127' MSL.

Trees beginning 903' from DER, 115' left of centerline, up to 2130' MSL.

Trees beginning 992' from DER, 240' right of centerline, up to 2133' MSL.

Tree 1054' from DER, 695' right of centerline, 2139' MSL.

Trees beginning 1148' from DER, 558' right of centerline, up to 2141' MSL.

Trees beginning 1174' from DER, 770' left of centerline, up to 2144' MSL.

Pole 6057' from DER, 1661' left of centerline, 29' AGL/2246' MSL.

Rwy 29, lighting 10' from DER, 11' left of centerline, 2' AGL/2092' MSL.

Lighting 10' from DER, 9' right of centerline, 2' AGL/2092' MSL.

GRAFTON, ND

HUTSON FLD (GAF)

TAKEOFF MINIMUMS AND (OBSTACLE) DEPARTURE PROCEDURES

AMDT 1 29JUL10 (21168) (FAA)

TAKEOFF MINIMUMS:

Rwys 8, 26, NA-Environmental.

TAKEOFF OBSTACLE NOTES:

Rwy 17, vehicle on roads beginning 23' from DER, 300' left of centerline, up to 15' AGL/837' MSL.

Tree 2612' from DER, 857' left of centerline, 100' AGL/929' MSL.

Rwy 35, building 107' from DER, 344' left of centerline, 17' AGL/836' MSL.

Electrical system 153' from DER, 398' left of centerline, 21' AGL/840' MSL.

Vehicle on roads beginning 260' from DER, 74' left of centerline, up to 15' AGL/841' MSL.

Obstruction light on airport beacon 471' from DER, 601' left of centerline, 54' AGL/873' MSL.

GRAND FORKS, ND

GRAND FORKS INTL (GFK)

TAKEOFF MINIMUMS AND (OBSTACLE) DEPARTURE PROCEDURES

AMDT 2 12MAR09 (09071) (FAA)

TAKEOFF OBSTACLE NOTES:

Rwy 9L, tree 127' from DER, 451' left of centerline, 12' AGL/853' MSL.

Rwy 27R, bush 38' from DER, 474' right of centerline, 5' AGL/844' MSL.

Rwy 35L, obstruction light on DME 645' from DER, 198' left of centerline, 21' AGL/860' MSL.

Rwy 35R, tree 1259' from DER, 521' right of centerline, 41' AGL/880' MSL.

Tree 1655' from DER, 271' left of centerline, 45' AGL/884' MSL.

22 FEB 2024 to 21 MAR 2024

22 FEB 2024 to 21 MAR 2024

TAKEOFF MINIMUMS, (OBSTACLE) DEPARTURE PROCEDURES, AND DIVERSE VECTOR AREA (RADAR VECTORS)

24025

NC-1

TAKEOFF MINIMUMS, (OBSTACLE) DEPARTURE PROCEDURES, AND DIVERSE VECTOR AREA (RADAR VECTORS)

24025

GRAND MARAIS, MN

GRAND MARAIS/COOK COUNTY (CKC)

TAKEOFF MINIMUMS AND (OBSTACLE) DEPARTURE PROCEDURES

AMDT 1 02MAR17 (17061) (FAA)

TAKEOFF OBSTACLE NOTES:

Rwy 10, runway lights beginning 9' from DER, 16' right of centerline, up to 2' AGL/1796' MSL.
Trees, REIL, runway lights, and terrain beginning 39' from DER, 77' right of centerline, up to 1818' MSL.
REIL 40' from DER, 76' left of centerline, 3' AGL/1797' MSL.
Trees beginning 147' from DER, 35' left of centerline, up to 1819' MSL.
Trees beginning 536' from DER, 249' right of centerline, up to 1820' MSL.
Trees beginning 739' from DER, 82' right of centerline, up to 1835' MSL.
Rwy 28, tree and terrain beginning 8' from DER, 202' left of centerline, up to 1838' MSL.
Tree and terrain beginning 43' from DER, 58' right of centerline, up to 1824' MSL.
Tree and terrain beginning 177' from DER, 41' right of centerline, up to 38' AGL/1837' MSL.
Trees beginning 359' from DER, 201' left of centerline, up to 1849' MSL.
Trees beginning 388' from DER, 223' right of centerline, up to 1847' MSL.
Trees beginning 552' from DER, 222' right of centerline, up to 1856' MSL.
Trees beginning 844' from DER, 236' right of centerline, up to 1865' MSL.
Trees and terrain beginning 1061' from DER, 320' right of centerline, up to 1867' MSL.
Trees beginning 1355' from DER, 536' right of centerline, up to 20' AGL/1880' MSL.
Trees beginning 1540' from DER, 123' right of centerline, up to 1896' MSL.
Trees beginning 1542' from DER, 5' left of centerline, up to 1867' MSL.
Trees beginning 2953' from DER, 92' right of centerline, up to 1900' MSL.
Trees beginning 3035' from DER, 32' left of centerline, up to 1890' MSL.
Trees beginning 4461' from DER, 344' right of centerline, up to 1924' MSL.

GRAND RAPIDS, MN

GRAND RAPIDS/ITASCA COUNTY-GORDON NEWSTROM FLD (GPZ)

TAKEOFF MINIMUMS AND (OBSTACLE) DEPARTURE PROCEDURES

AMDT 4A 20JUN19 (21112) (FAA)

TAKEOFF MINIMUMS:

Rwys 5, 23, NA-Environmental.

TAKEOFF OBSTACLE NOTES:

Rwy 16, lighting beginning 4' from DER, on centerline, up to 1' AGL/1357' MSL.
Lighting 11' from DER, 30' left of centerline, 2' AGL/1357' MSL.
Tree 398' from DER, 582' left of centerline, 1368' MSL.
Trees beginning 1122' from DER, 569' right of centerline, up to 52' AGL/1409' MSL.
Tree 1654' from DER, 898' left of centerline, 1410' MSL.
Tree 2232' from DER, 1086' right of centerline, 1421' MSL.
Trees beginning 2267' from DER, 502' right of centerline, up to 1425' MSL.
Tree 2859' from DER, 1240' left of centerline, 1429' MSL.
Tree 3055' from DER, 1264' right of centerline, 1434' MSL.
Trees beginning 3187' from DER, 1130' right of centerline, up to 1443' MSL.
Tree 3221' from DER, 1175' left of centerline, 1441' MSL.
Trees beginning 3255' from DER, 1284' right of centerline, up to 1448' MSL.
Trees beginning 3329' from DER, 1337' left of centerline, up to 1447' MSL.
Rwy 34, lighting beginning 3' from DER, 59' left of centerline, up to 2' AGL/1299' MSL.
Lighting 9' from DER, 50' right of centerline, 2' AGL/1299' MSL.
Lighting, poles beginning 9' from DER, 29' left of centerline, up to 2' AGL/1300' MSL.
Tree 3267' from DER, 1353' left of centerline, 109' AGL/1405' MSL.

GRANITE FALLS, MN

GRANITE FALLS MUNI/LENZEN-ROE-FAGEN-MEML FLD (GDB)

TAKEOFF MINIMUMS AND (OBSTACLE) DEPARTURE PROCEDURES

ORIG 06MAY10 (21112) (FAA)

TAKEOFF OBSTACLE NOTES:

Rwy 15, trees beginning 1780' from DER, 94' left of centerline, up to 100' AGL/1149' MSL.
Rwy 33, trees beginning 1196' from DER, right and left of centerline, up to 100' AGL/1149' MSL.
Power line 1242' from DER, 762' left of centerline, 80' AGL/1129' MSL.
Train 1390' from DER, 149' left of centerline, 23' AGL/1162' MSL.
Vehicle on road 1389' from DER, 156' left of centerline, up to 15' AGL/1154' MSL.

TAKEOFF MINIMUMS, (OBSTACLE) DEPARTURE PROCEDURES, AND DIVERSE VECTOR AREA (RADAR VECTORS)

24025

NC-1

TAKEOFF MINIMUMS, (OBSTACLE) DEPARTURE PROCEDURES, AND DIVERSE VECTOR AREA (RADAR VECTORS)

24025

GREGORY, SD

GREGORY MUNI - FLYNN FLD (9D1)

TAKEOFF MINIMUMS AND (OBSTACLE) DEPARTURE PROCEDURES

ORIG-A 01JUL10 (21140) (FAA)

TAKEOFF MINIMUMS:

Rwy 31, 400-2¼ or std. w/min. climb of 228' per NM to 2600.

TAKEOFF OBSTACLE NOTES:

Rwy 31, tower 11377' from DER, 816' right of centerline, 210' AGL/2491' MSL.

GWINNER, ND

GWINNER-ROGER MELROE FIELD (GWR)

TAKEOFF MINIMUMS AND (OBSTACLE) DEPARTURE PROCEDURES

AMDT1 18SEP14 (14261) (FAA)

TAKEOFF MINIMUMS:

Rwys 6, 24, NA-Environment.

DEPARTURE PROCEDURE:

Rwy 34, climbing right turn heading 010° to 2000 before proceeding on course.

TAKEOFF OBSTACLE NOTES:

Rwy 34, tree 84' from DER, 469' right of centerline, 43' AGL/1293' MSL.

Pole 523' from DER, 626' right of centerline, 47' AGL/1296' MSL.

HALLOCK, MN

HALLOCK MUNI (HCO)

TAKEOFF MINIMUMS AND (OBSTACLE) DEPARTURE PROCEDURES

ORIG 05MAY11 (11125) (FAA)

TAKEOFF OBSTACLE NOTES:

Rwy 13, tree 1076' from DER, 620' right of centerline, 100' AGL/919' MSL.

Trees beginning 81' from DER, from 472' left of centerline, up to 100' AGL/919' MSL.

Rwy 31, tree 1668' from DER, 560' right of centerline, 100' AGL/919' MSL.

HARVEY, ND

HARVEY MUNI (5H4)

TAKEOFF MINIMUMS AND (OBSTACLE) DEPARTURE PROCEDURES

ORIG 23SEP10 (10266) (FAA)

TAKEOFF OBSTACLE NOTES:

Rwy 11, vehicle on road beginning 50' from DER, 318' left of centerline, up to 15' AGL/1654' MSL.

Tree 300' from DER, 329' right of centerline, 20' AGL/1621' MSL.

Tree 350' from DER, 444' right of centerline, 20' AGL/1619' MSL.

Rwy 29, vehicle on road beginning 4' from DER, left and right of centerline, up to 15' AGL/1654' MSL.

Rising terrain beginning 7' from DER, 31' left of centerline, up to 1608' MSL.

HAWLEY, MN

HAWLEY MUNI (04Y)

TAKEOFF MINIMUMS AND (OBSTACLE) DEPARTURE PROCEDURES

ORIG 15MAR07 (07074) (FAA)

TAKEOFF OBSTACLE NOTES:

Rwy 34, road 15' from DER, 421' left of centerline, 15' AGL/1224' MSL.

22 FEB 2024 to 21 MAR 2024

22 FEB 2024 to 21 MAR 2024

TAKEOFF MINIMUMS, (OBSTACLE) DEPARTURE PROCEDURES, AND DIVERSE VECTOR AREA (RADAR VECTORS)

24025

NC-1

TAKEOFF MINIMUMS, (OBSTACLE) DEPARTURE PROCEDURES, AND DIVERSE VECTOR AREA (RADAR VECTORS)

24025

HAZEN, ND

MERCER COUNTY RGNL (HZE)

TAKEOFF MINIMUMS AND (OBSTACLE) DEPARTURE PROCEDURES

AMDT 1 20APR23 (23110) (FAA)

TAKEOFF MINIMUMS:

Rwy 15, 300-1¼ or std. w/min. climb of 296' per NM to 2100 or 1000-3 for climb in visual conditions.

Rwy 33, std. w/min. climb of 215' per NM to 2700 or 1000-3 for climb in visual conditions.

VCOA:

All runways, obtain ATC approval for VCOA when requesting IFR clearance, climb in visual conditions to cross Mercer County Rgnl airport at or above 2600 before proceeding on course.

TAKEOFF OBSTACLE NOTES:

Rwy 15, fence 195' from DER, 301' left of centerline, 7' AGL/1826' MSL.

Fence, terrain beginning 341' from DER, 288' left of centerline, up to 2' AGL/1830' MSL.

Fence, terrain beginning 603' from DER, 299' left of centerline, up to 2' AGL/1837' MSL.

Fence, terrain beginning 749' from DER, 270' left of centerline, up to 6' AGL/1841' MSL.

Fence beginning 949' from DER, 108' left of centerline, up to 9' AGL/1843' MSL.

Tree 4183' from DER, 1609' right of centerline, 1969' MSL.

Tree 4465' from DER, 1668' left of centerline, 1979' MSL.

Tree 4549' from DER, 1712' right of centerline, 1979' MSL.

Tree 4954' from DER, 1787' right of centerline, 1989' MSL.

Tree 5267' from DER, 1866' right of centerline, 1999' MSL.

Tree 1.1 NM from DER, 2278' right of centerline, 2009' MSL.

Tree 1.3 NM from DER, 2569' right of centerline, 2019' MSL.

Rwy 33, fence 6' from DER, 298' left of centerline, 5' AGL/1790' MSL.

Trees beginning 1292' from DER, 520' right of centerline, up to 1833' MSL.

HETTINGER, ND

HETTINGER/JB LINDQUIST RGNL (HEI)

TAKEOFF MINIMUMS AND (OBSTACLE) DEPARTURE PROCEDURES

AMDT 3 08NOV18 (21112) (FAA)

TAKEOFF MINIMUMS:

Rwys 17, 35, NA - Environmental.

Rwy 12, 300-1¼ or std. w/min. climb of 301' per NM to 3000.

DEPARTURE PROCEDURE:

Rwy 30, climb heading 308° to 3200 before turning right.

TAKEOFF OBSTACLE NOTES:

Rwy 12, fence 26' from DER, 435' right of centerline, 2703' MSL.

Tree 1655' from DER, 857' left of centerline, 2743' MSL.

Tree 1763' from DER, 733' left of centerline, 2754' MSL.

Tree 2443' from DER, 1095' left of centerline, 2764' MSL.

Tree 3135' from DER, 628' left of centerline, 2779' MSL.

Tree 3137' from DER, 1028' left of centerline, 2780' MSL.

Tree 3403' from DER, 1276' left of centerline, 2786' MSL.

Tree 3513' from DER, 1427' left of centerline, 2792' MSL.

Tree 3527' from DER, 1216' left of centerline, 2809' MSL.

Tree 3589' from DER, 1354' left of centerline, 2816' MSL.

Trees beginning 3613' from DER, 1137' left of centerline, up to 2826' MSL.

Tree 4520' from DER, 1293' left of centerline, 2838' MSL.

Trees beginning 4569' from DER, 1262' left of centerline, up to 60' AGL/2849' MSL.

Tree 5487' from DER, 1936' left of centerline, 60' AGL/2869' MSL.

Tower, trees beginning 5516' from DER, 1129' left of centerline, up to 100' AGL/2906' MSL.

Trees beginning 5926' from DER, 1917' left of centerline, up to 60' AGL/2859' MSL.

Rwy 30, fence 26' from DER, 401' left of centerline, 2706' MSL.

Terrain 93' from DER, 252' right of centerline, 2709' MSL.

Fence 199' from DER, 349' right of centerline, 2713' MSL.

Terrain 290' from DER, 569' right of centerline, 2714' MSL.

Terrain 888' from DER, 703' right of centerline, 2732' MSL.

Fence 1134' from DER, 670' right of centerline, 2743' MSL.

HIBBING, MN

RANGE RGNL (HIB)

TAKEOFF MINIMUMS AND (OBSTACLE) DEPARTURE PROCEDURES

AMDT 6 05AUG04 (04218) (FAA)

DEPARTURE PROCEDURE:

Rwy 22, climb via heading 227° to 2200 before turning right.

Rwy 31, climb via heading 310° to 2200 before turning left.

TAKEOFF OBSTACLE NOTES:

Rwy 4, antenna on pole, 361' from DER, 409' right of centerline, 1377' MSL.

Rwy 13, obstacle light on pole, 1184' from DER, 636' left of centerline.

Numerous trees beginning 1291' from DER, 745' left of centerline up to 1419' MSL.

Trees 1497' from DER, 563' right of centerline, 1388' MSL.

Rwy 22, multiple trees beginning 368' from DER, 170' right of centerline, up to 1416' MSL.

Multiple trees beginning 413' from DER, 117' left of centerline, up to 1400' MSL.

Rwy 31, light standard, 865' from DER, 595' right of centerline, 1381' MSL.

TAKEOFF MINIMUMS, (OBSTACLE) DEPARTURE PROCEDURES, AND DIVERSE VECTOR AREA (RADAR VECTORS)

24025

TAKEOFF MINIMUMS, (OBSTACLE) DEPARTURE PROCEDURES, AND DIVERSE VECTOR AREA (RADAR VECTORS)

24025

HIGHMORE, SD

HIGHMORE MUNI (9D0)

TAKEOFF MINIMUMS AND (OBSTACLE) DEPARTURE PROCEDURES

ORIG 15SEP16 (16259) (FAA)

TAKEOFF OBSTACLE NOTES:

Rwy 13, tank 245' from DER, 564' left of centerline, 44' AGL/1890' MSL.

Tank 9' from DER, 492' left of centerline, 30' AGL/1877' MSL.

Building 169' from DER, 449' left of centerline, 23' AGL/1871' MSL.

Vehicles on road beginning 70' from DER, 397' left of centerline, 15' AGL/1865' MSL.

Ground beginning 7' from DER, 413' right of centerline, 0' AGL/1856' MSL.

NAVAID 10' from DER, 11' right of centerline, 3' AGL/1855' MSL.

Rwy 31, fence beginning 83' from DER, 453' left of centerline, up to 12' AGL/1852' MSL.

Fence beginning 129' from DER, 449' right of centerline, up to 12' AGL/1851' MSL.

Trees beginning 1079' from DER, 397' left of centerline, up to 50' AGL/1898' MSL.

Vertical structure 25' from DER, 450' right of centerline, up to 33' AGL/1845' MSL.

NAVAID 9' from DER, 8' right of centerline, 2' AGL/1843' MSL.

Vertical structure 201' from DER, 439' left of centerline, 32' AGL/1847' MSL.

HILLSBORO, ND

HILLSBORO MUNI (3H4)

TAKEOFF MINIMUMS AND (OBSTACLE) DEPARTURE PROCEDURES

AMDT 1 08JAN15 (15008) (FAA)

DEPARTURE PROCEDURE:

Rwy 16, climb heading 166° to 1700 before turning right.

Rwy 34, climb heading 346° to 2000 before turning left.

TAKEOFF OBSTACLE NOTES:

Rwy 16, REILs 11' from DER, 52' right of centerline, 1' AGL/906' MSL.

Vehicles on road beginning 9' from DER, 463' right of centerline, up to 17' AGL/922' MSL.

Vehicles on road beginning 109' from DER, 326' right of centerline, up to 17' AGL/923' MSL.

Vehicles on road beginning 355' from DER, 326' right of centerline, 17' AGL/924' MSL.

Vehicles on roads beginning 632' from DER, 61' right of centerline, 17' AGL/925' MSL.

Rwy 34, post 4' from DER, 140' right of centerline, 5' AGL/908' MSL.

NAVAID 21' from DER, 126' left of centerline, 2' AGL/907' MSL.

Vehicles on road beginning 65' from DER, 411' right of centerline, up to 20' AGL/919' MSL.

HINCKLEY, MN

FIELD OF DREAMS (04W)

TAKEOFF MINIMUMS AND (OBSTACLE) DEPARTURE PROCEDURES

ORIG 14FEB08 (08045) (FAA)

TAKEOFF OBSTACLE NOTES:

Rwy 6, Tree 82' from DER, 480' right of centerline, 100' AGL/1114' MSL.

Tree 143' from DER, 161' left of centerline, 100' AGL/1114' MSL.

Rwy 24, Tree 48' from DER, 165' left of centerline, 100' AGL/1124' MSL.

HOT SPRINGS, SD

HOT SPRINGS MUNI (HSR)

TAKEOFF MINIMUMS AND (OBSTACLE) DEPARTURE PROCEDURES

AMDT 1 26JUL12 (12208) (FAA)

TAKEOFF MINIMUMS:

Rwys 6, 24, NA-Environmental.

Rwy 1, 400-2½ or std. w/min. climb of 235' per NM to 3700.

Rwy 19, 400-2¼ or std. w/min. climb of 255' per NM to 3600.

DEPARTURE PROCEDURE:

Rwy 1, climb heading 026° to 4700 before turning westbound.

Rwy 19, climb heading 192° to 4700 before turning westbound.

TAKEOFF OBSTACLE NOTES:

Rwy 1, terrain 55' from DER, 468' right of centerline, 3144' MSL.

Vehicle on road beginning 312' from DER, left and right of centerline, up to 15' AGL/3154' MSL.

Trees beginning 528' from DER, left and right of centerline, up to 100' AGL/3239' MSL.

Trees 2.1 NM from DER, 3246' left of centerline, up to 100' AGL/3519' MSL.

Rwy 19, vehicle on road beginning 5' from DER, 369' left of centerline, up to 15' AGL/3161' MSL.

Vehicle on road beginning 407' from DER, left and right of centerline, up to 15' AGL/3166' MSL.

Poles beginning 607' from DER, left and right of centerline, up to 30' AGL/3181' MSL.

Multiple trees and poles beginning 1875' from DER, left and right of centerline, up to 100' AGL/3281' MSL.

Buildings 3031' from DER, 149' left of centerline, up to 20' AGL/3230' MSL.

Fence beginning 3033' from DER, 559' left of centerline, up to 6' AGL/3236' MSL.

Rising terrain beginning 3477' from DER, 545' left of centerline, up to 3241' MSL.

Trees beginning 1.6 NM from DER, 764' left of centerline, up to 100' AGL/3489' MSL.

Power lines beginning 1.4 NM from DER, 166' left of centerline, up to 120' AGL/3440' MSL.

TAKEOFF MINIMUMS, (OBSTACLE) DEPARTURE PROCEDURES, AND DIVERSE VECTOR AREA (RADAR VECTORS)

24025

NC-1

TAKEOFF MINIMUMS, (OBSTACLE) DEPARTURE PROCEDURES, AND DIVERSE VECTOR AREA (RADAR VECTORS)

24025

HURON, SD

HURON RGNL (HON)

TAKEOFF MINIMUMS AND (OBSTACLE) DEPARTURE PROCEDURES
AMDT 5A 07OCT21 (21280) (FAA)

TAKEOFF OBSTACLE NOTES:

Rwy 12, lighting 40' from DER, 114' left of centerline, 3' AGL/1286' MSL.
Lighting 40' from DER, 115' right of centerline, 3' AGL/1286' MSL.
Tree 290' from DER, 265' right of centerline, 1293' MSL.
Pole 917' from DER, 524' left of centerline, 24' AGL/1307' MSL.
Trees beginning 1450' from DER, 582' left of centerline, up to 1341' MSL.
Trees beginning 1608' from DER, 64' right of centerline, up to 1344' MSL.
Tree 2229' from DER, 171' right of centerline, 1345' MSL.
Trees beginning 2263' from DER, 169' right of centerline, up to 1350' MSL.
Tree 2317' from DER, 9' left of centerline, 1344' MSL.
Rwy 18, terrain 13' from DER, 302' left of centerline, 1286' MSL.
Trees, lighting beginning 15' from DER, 78' right of centerline, up to 1314' MSL.
Lighting 42' from DER, 76' left of centerline, 3' AGL/1287' MSL.
Vegetation 195' from DER, 345' left of centerline, 1292' MSL.
Tree 235' from DER, 307' left of centerline, 1303' MSL.
Tree 302' from DER, 471' right of centerline, 1333' MSL.
Trees beginning 421' from DER, 434' right of centerline, up to 1337' MSL.
Trees, terrain beginning 538' from DER, 459' right of centerline, up to 1349' MSL.
Trees beginning 1136' from DER, 235' left of centerline, up to 1319' MSL.
Tree 1228' from DER, 279' left of centerline, 1321' MSL.
Trees, pole beginning 1370' from DER, right of centerline, up to 1352' MSL.
Trees beginning 1411' from DER, 527' left of centerline, up to 1356' MSL.
Trees beginning 1737' from DER, 7' left of centerline, up to 1357' MSL.
Trees, pole beginning 1783' from DER, 183' left of centerline, up to 1363' MSL.
Rwy 30, lighting 4' from DER, 10' right of centerline, 2' AGL/1290' MSL.
Rwy 36, trees beginning 59' from DER, 320' left of centerline, up to 1328' MSL.
Fence 192' from DER, 326' right of centerline, 11' AGL/1293' MSL.
Tree 203' from DER, 534' left of centerline, 1332' MSL.
Trees beginning 250' from DER, 14' right of centerline, up to 1331' MSL.
Trees beginning 270' from DER, 2' left of centerline, up to 1333' MSL.
Tree 1961' from DER, 105' right of centerline, 1333' MSL.
Tree 2116' from DER, 4' left of centerline, 1340' MSL.
Tree 2142' from DER, 8' right of centerline, 1343' MSL.
Tree 2160' from DER, 58' left of centerline, 1343' MSL.

HUTCHINSON, MN

HUTCHINSON MUNI/BUTLER FLD (HCD)

TAKEOFF MINIMUMS AND (OBSTACLE) DEPARTURE PROCEDURES
ORIG 30JUN11 (22027) (FAA)

TAKEOFF OBSTACLE NOTES:

Rwy 15, tree 3342' from DER, 425' right of centerline, 89' AGL/1148' MSL.
Trees beginning 545' from DER, 394' left of centerline, up to 64' AGL/1113' MSL.
Rwy 33, tree 994' from DER, 561' right of centerline, 40' AGL/1 099' MSL.

INTERNATIONAL FALLS, MN

FALLS INTL/EINARSON FLD (INL)

TAKEOFF MINIMUMS AND (OBSTACLE) DEPARTURE PROCEDURES
AMDT 4A 07OCT21 (21336) (FAA)

TAKEOFF OBSTACLE NOTES:

Rwy 4, tree 251' from DER, 542' left of centerline, 48' AGL/1225' MSL.
Trees beginning 343' from DER, 296' left of centerline, up to 72' AGL/1249' MSL.
Rwy 13, vehicle on road 1004' from DER, 766' left of centerline, 1195' MSL.
Pole 1091' from DER, 702' right of centerline, 33' AGL/1207' MSL.
Trees beginning 1998' from DER, 774' left of centerline, up to 1233' MSL.
Trees beginning 2176' from DER, 531' left of centerline, up to 60' AGL/1236' MSL.
Rwy 22, tree 433' from DER, 273' left of centerline, 1199' MSL.
Tree 786' from DER, 389' left of centerline, 121' MSL.
Tree 1144' from DER, 133' right of centerline, 1208' MSL.
Rwy 31, tree 969' from DER, 751' left of centerline, 1236' MSL.

22 FEB 2024 to 21 MAR 2024

22 FEB 2024 to 21 MAR 2024

TAKEOFF MINIMUMS, (OBSTACLE) DEPARTURE PROCEDURES, AND DIVERSE VECTOR AREA (RADAR VECTORS)

24025

NC-1

TAKEOFF MINIMUMS, (OBSTACLE) DEPARTURE PROCEDURES, AND DIVERSE VECTOR AREA (RADAR VECTORS)

24025

JACKSON, MN

JACKSON MUNI (MJQ)

TAKEOFF MINIMUMS AND (OBSTACLE) DEPARTURE PROCEDURES

AMDT 1 25JAN24 (24025) (FAA)

TAKEOFF MINIMUMS:

Rwys 4, 22, NA-Environmental.

DEPARTURE PROCEDURE:

Rwy 14, climb on heading 134° to 1900 before turning right.

TAKEOFF OBSTACLE NOTES:

Rwy 14, terrain 7' from DER, 55' left of centerline, 1447' MSL.

Light poles 8' from DER, 321' right of centerline, 3' AGL/1447' MSL.

Light poles 8' from DER, 165' right of centerline, 4' AGL/1448' MSL.

Traverse ways beginning 498' from DER, 394' right of centerline, up to 1462' MSL.

Transmission line 1881' from DER, 1001' left of centerline, 49' AGL/1498' MSL.

Transmission line 2100' from DER, 813' left of centerline, 58' AGL/1507' MSL.

Transmission line 2654' from DER, 394' left of centerline, 68' AGL/1517' MSL.

Rwy 32, terrain 8' from DER, 192' right of centerline, 1433' MSL.

Traverse ways beginning 413' from DER, 440' left of centerline, up to 1447' MSL.

Tree 841' from DER, 566' right of centerline, 44' AGL/1472' MSL.

Tree 873' from DER, 526' right of centerline, 46' AGL/1475' MSL.

Tree 1008' from DER, 732' right of centerline, 59' AGL/1492' MSL.

Trees beginning 1057' from DER, 326' right of centerline, up to 69' AGL/1501' MSL.

Trees beginning 1232' from DER, 394' right of centerline, up to 83' AGL/1515' MSL.

JAMESTOWN, ND

JAMESTOWN RGNL (JMS)

TAKEOFF MINIMUMS AND (OBSTACLE) DEPARTURE PROCEDURES

AMDT 1 30AUG07 (07242) (FAA)

TAKEOFF OBSTACLE NOTES:

Rwy 22, antenna and tank beginning 2960' from DER, 1007' left of centerline, up to 150' AGL/1631' MSL.

Rwy 31, multiple trees beginning 2129' from DER 47' right of centerline, up to 60' AGL/1560' MSL.

KENMARE, ND

KENMARE MUNI (7K5)

TAKEOFF MINIMUMS AND (OBSTACLE) DEPARTURE PROCEDURES

ORIG 05MAY11 (11125) (FAA)

TAKEOFF OBSTACLE NOTES:

Rwy 8, vehicles on roadway 359' from DER, left and right of centerline, up to 15' AGL/1980' MSL.

Trees 374' from DER, 359' right of centerline, 50' AGL/2004' MSL.

Rwy 26, aircraft on taxiway beginning abeam DER, 385' right of centerline, up to 17' AGL/1981' MSL.

Hangars beginning 147' from DER, 506' right of centerline, up to 30' AGL/1994' MSL.

Pole 1259' from DER, 49' right of centerline, 40' AGL/2002' MSL.

Trees beginning 1342' from DER, 85' right of centerline, up to 50' AGL/2014' MSL.

KILLDEER, ND

DUNN COUNTY WEYDAHL FLD (9Y1)

TAKEOFF MINIMUMS AND (OBSTACLE) DEPARTURE PROCEDURES

ORIG 28JAN21 (23110) (FAA-O)

TAKEOFF MINIMUMS:

Rwy 31, std. w/min. climb of 306' per NM to 4100 or 1400-3 for VCOA.

DEPARTURE PROCEDURE:

Rwy 13, climb on heading 126° to 2700 before proceeding on course.

VCOA:

Rwy 31, obtain ATC approval for VCOA when requesting IFR clearance. Climb in visual conditions to cross Dunn County

Weydahl Fld at or above 3500 before proceeding on course.

TAKEOFF OBSTACLE NOTES:

Rwy 31, T-L towers beginning 1.03 NM from DER, 404' right of centerline, up to 125' AGL/2388' MSL.

KINDRED, ND

ROBERT ODEGAARD FLD (K74)

TAKEOFF MINIMUMS AND (OBSTACLE) DEPARTURE PROCEDURES

ORIG-A 05MAR15 (21280) (FAA)

TAKEOFF OBSTACLE NOTES:

Rwy 29, tree 991' from DER, 367' left of centerline, 38' AGL/982' MSL.

Tree 1073' from DER, 221' left of centerline, 38' AGL/982' MSL.

TAKEOFF MINIMUMS, (OBSTACLE) DEPARTURE PROCEDURES, AND DIVERSE VECTOR AREA (RADAR VECTORS)

24025

TAKEOFF MINIMUMS, (OBSTACLE) DEPARTURE PROCEDURES, AND DIVERSE VECTOR AREA (RADAR VECTORS)

24025

LANGDON, ND

ROBERTSON FLD (D55)

TAKEOFF MINIMUMS AND (OBSTACLE) DEPARTURE PROCEDURES

ORIG 03JUN10 (22083) (FAA)

TAKEOFF MINIMUMS:

Rwys 8, 26, NA-Environmental.

TAKEOFF OBSTACLE NOTES:

Rwy 14, vehicles on road beginning 479' to 684' from DER, from 238' to 413' left of centerline, up to 15' AGL/1627' MSL.**Rwy 32**, windsock 13' from DER, 416' right of centerline, 16' AGL/1619' MSL.

Fence 24' from DER, 301' left of centerline, 5' AGL/1608' MSL.

Fence 199' from DER, 293' left of centerline, 5' AGL/1608' MSL.

Trees beginning 485' from DER 203' right of centerline, up to 30' AGL/1628' MSL.

Trees beginning 1912' from DER, from 241' to 418' left of centerline, up to 78' AGL/1677' MSL.

LAKOTA, ND

LAKOTA MUNI (5L0)

TAKEOFF MINIMUMS AND (OBSTACLE) DEPARTURE PROCEDURES

ORIG 22JUN17 (17173) (FAA)

TAKEOFF OBSTACLE NOTES:

Rwy 15, tree 129' from DER, 141' right of centerline, 1511' MSL.

Tree 849' from DER, 214' left of centerline, 1531' MSL.

Tree 877' from DER, 202' left of centerline, 1532' MSL.

T-L tower 906' from DER, 439' left of centerline, 27' AGL/1533' MSL.

Pole beginning 907' from DER, 430' left of centerline, up to 29' AGL/1534' MSL.

Trees beginning 979' from DER, 197' left of centerline, up to 1553' MSL.

Rwy 33, tree 29' from DER, 290' right of centerline, 1524' MSL.

Building 482' from DER, 576' left of centerline, 23' AGL/1531' MSL.

Road (N) beginning 587' from DER, 113' right of centerline, up to 1527' MSL.

Tree 817' from DER, 536' right of centerline, 1541' MSL.

Trees beginning 894' from DER, 173' right of centerline, up to 1554' MSL.

Trees beginning 904' from DER, 175' right of centerline, up to 1557' MSL.

Trees beginning 937' from DER, 158' right of centerline, up to 1558' MSL.

Trees beginning 1004' from DER, 56' right of centerline, up to 1560' MSL.

Tree 1063' from DER, 72' left of centerline, 1542' MSL.

Trees and pole beginning 1099' from DER, 77' left of centerline, up to 1551' MSL.

LEMMON, SD

LEMMON MUNI (LEM)

TAKEOFF MINIMUMS AND (OBSTACLE) DEPARTURE PROCEDURES

AMDT 2 02DEC21 (21336) (FAA)

TAKEOFF MINIMUMS:

Rwys 6, 24, NA-Environmental.**Rwy 12**, 300-2 or std. w/min. climb of 215' per NM to 3000, or alternatively, with standard takeoff minimums and a normal 200' per NM climb gradient, takeoff must occur no later than 1600' prior to DER.

TAKEOFF OBSTACLE NOTES:

Rwy 12, rising terrain beginning 44' from DER, 318' right of centerline, up to 2575' MSL.

Vehicle on road 789' from DER, 650' left of centerline, 2590' MSL.

Vehicle on road 861' from DER, 549' left of centerline, 2593' MSL vehicle on road, beginning 928' from DER, 369' left of centerline, up to 2596' MSL.

Tree 1.6 NM from DER, 2550' left of centerline, up to 100' AGL/2829' MSL.

Rwy 30, vehicle on road 445' from DER, 441' left of centerline, 2581' MSL.

Vehicle on road beginning 558' from DER, 232' left of centerline, up to 2583' MSL.

Tree 5566' from DER, 1918' left of centerline, 100' AGL/2719' MSL.

LINTON, ND

LINTON MUNI (7L2)

TAKEOFF MINIMUMS AND (OBSTACLE) DEPARTURE PROCEDURES

ORIG 22AUG13 (13234) (FAA)

TAKEOFF OBSTACLE NOTES:

Rwy 9, trees beginning 902' from DER, 210' right of centerline, up to 100' AGL/1830' MSL.

Flag pole 37' from DER, 465' left of centerline, 30' AGL/1810' MSL.

Vehicle on road beginning 72' from DER, 237' right of centerline, up to 15' AGL/1815' MSL.

Rwy 27, trees beginning 14' from DER, 286' left of centerline, up to 100' AGL/1806' MSL.

TAKEOFF MINIMUMS, (OBSTACLE) DEPARTURE PROCEDURES, AND DIVERSE VECTOR AREA (RADAR VECTORS)

24025

TAKEOFF MINIMUMS, (OBSTACLE) DEPARTURE PROCEDURES, AND DIVERSE VECTOR AREA (RADAR VECTORS)

24025

LISBON, ND

LISBON MUNI (6L3)

TAKEOFF MINIMUMS AND (OBSTACLE) DEPARTURE PROCEDURES

ORIG 05JAN17 (17005) (FAA)

TAKEOFF MINIMUMS:

Rwy 3, 21, NA, Environmental.

TAKEOFF OBSTACLE NOTES:

Rwy 14, terrain beginning 2' from DER, 168' right of centerline, up to 1231' MSL.

Pole 51' from DER, 499' left of centerline, 1250' MSL.

Vehicle on road beginning 441' from DER, left and right of centerline, up to 1248' MSL.

Trees beginning 1136' from DER, 405' right of centerline, up to 1280' MSL.

Rwy 32, terrain beginning 60' from DER, 297' left of centerline, up to 1234' MSL.

Tree 109' from DER, 167' left of centerline, 1238' MSL.

Fence beginning 123' from DER, 497' right of centerline, up to 3' AGL/1235' MSL.

Fence and tree beginning 270 from DER, 149' right of centerline, up to 1242' MSL.

LITCHFIELD, MN

LITCHFIELD MUNI (LJF)

TAKEOFF MINIMUMS AND (OBSTACLE) DEPARTURE PROCEDURES

AMDT 1 23SEP10 (10266) (FAA)

DEPARTURE PROCEDURE:

Rwy 31, climb heading 316° to 1700 before turning left.

TAKEOFF OBSTACLE NOTES:

Rwy 13, trees beginning 11' from DER, 417' left and right of centerline, up to 90' AGL/1234' MSL.

Trees beginning 1251' from DER, 830' left of centerline, up to 89' AGL/1228' MSL.

Rwy 31, trees beginning 958' from DER, 73' left of centerline, up to 46' AGL/1185' MSL.

Trees beginning 13' from DER, 370' right of centerline, up to 95' AGL/1234' MSL.

LITTLE FALLS, MN

LITTLE FALLS/MORRISON COUNTY-LINDBERGH FLD (LXL)

TAKEOFF MINIMUMS AND (OBSTACLE) DEPARTURE PROCEDURES

AMDT 4A 01MAY14 (21196) (FAA)

TAKEOFF MINIMUMS:

Rwy 13, 300-1¼ or std. w/min. climb of 301' per NM to 1500.**Rwys 18, 36**, NA-Environmental.

DEPARTURE PROCEDURE:

Rwy 31, climb heading 308° to 1600 before turning right.

TAKEOFF OBSTACLE NOTES:

Rwy 13, numerous trees beginning 76' from DER, right and left of centerline, up to 100' AGL/1389' MSL.**Rwy 31**, numerous trees beginning 1986' from DER, right and left of centerline, up to 100' AGL/1214' MSL.

LONG PRAIRIE, MN

TODD FLD (14Y)

TAKEOFF MINIMUMS AND (OBSTACLE) DEPARTURE PROCEDURES

AMDT 1 21MAY20 (22083) (FAA)

TAKEOFF OBSTACLE NOTES:

Rwy 16, roads beginning 62' from DER, 476' left of centerline, up to 1342' MSL.

Terrain 89' from DER, 228' right of centerline, 1330' MSL.

Rwy 34, buildings and light beginning 0' from DER, 114' right of centerline, up to 21' AGL/1349' MSL.

Light 9' from DER, 18' left of centerline, 2' AGL/1334' MSL.

Trees, building, and pole beginning 313' from DER, 110' left of centerline, up to 1361' MSL.

Poles beginning 652' from DER, 638' right of centerline, up to 36' AGL/1363' MSL.

Trees and pole beginning 738' from DER, 98' left of centerline, up to 1375' MSL.

Trees beginning 851' from DER, 497' left of centerline, up to 1383' MSL.

LONGVILLE, MN

LONGVILLE MUNI (XVG)

TAKEOFF MINIMUMS AND (OBSTACLE) DEPARTURE PROCEDURES

AMDT 1 21MAY20 (20142) (FAA)

TAKEOFF OBSTACLE NOTES:

Rwy 13, vehicle on road 1' from DER, 125' left of centerline, 1338' MSL.

Tree 5' from DER, 428' left of centerline, 15' AGL/1341' MSL.

Trees, vehicles on road beginning 9' from DER, 55' left of centerline, up to 1343' MSL.

Trees, vehicles on road beginning 33' from DER, 81' right of centerline, up to 1350' MSL.

Trees beginning 179' from DER, 124' right of centerline, up to 1364' MSL.

Trees beginning 188' from DER, 103' right of centerline, up to 1365' MSL.

Trees beginning 217' from DER, 120' right of centerline, up to 1385' MSL.

Trees beginning 269' from DER, 10' right of centerline, up to 1388' MSL.

Tree 334' from DER, 354' left of centerline, 26' AGL/1344' MSL.

Tree 381' from DER, 498' left of centerline, 1366' MSL.

Tree 444' from DER, 592' left of centerline, 1380' MSL.

CONT

TAKEOFF MINIMUMS, (OBSTACLE) DEPARTURE PROCEDURES, AND DIVERSE VECTOR AREA (RADAR VECTORS)

24025

NC-1

TAKEOFF MINIMUMS, (OBSTACLE) DEPARTURE PROCEDURES, AND DIVERSE VECTOR AREA (RADAR VECTORS)

24025

LONGVILLE, MN (CON'T)

LONGVILLE MUNI (XVG) (CON'T)

Rwy 13 (CON'T), trees beginning 495' from DER, 295' left of centerline, up to 1392' MSL.

Trees beginning 748' from DER, 595' left of centerline, up to 1393' MSL.

Trees beginning 853' from DER, 2' left of centerline, up to 1403' MSL.

Trees beginning 1444' from DER, 12' right of centerline, up to 1389' MSL.

Trees beginning 1722' from DER, 69' right of centerline, up to 1393' MSL.

Trees beginning 1790' from DER, 22' right of centerline, up to 64' AGL/1395' MSL.

Trees beginning 1857' from DER, 9' right of centerline, up to 85' AGL/1399' MSL.

Trees beginning 2038' from DER, 5' right of centerline, up to 1406' MSL.

Trees beginning 2455' from DER, 46' left of centerline, up to 1406' MSL.

Rwy 31, vegetation 1' from DER, 154' right of centerline, 6' AGL/1340' MSL.

Vegetation, lighting beginning 2' from DER, 47' right of centerline, up to 10' AGL/1343' MSL.

Terrain 8' from DER, 186' left of centerline, 1335' MSL.

Building, lighting, sign beginning 9' from DER, 77' left of centerline, up to 17' AGL/1352' MSL.

Building, terrain, vehicles on road, vegetation, pole, sign beginning 23' from DER, 126' left of centerline, up to 64' AGL/1399' MSL.

Vegetation beginning 43' from DER, 103' right of centerline, up to 14' AGL/1347' MSL.

Vehicles on road, vegetation, trees beginning 198' from DER, 139' right of centerline, up to 1349' MSL.

Trees, vehicles on road beginning 288' from DER, 131' right of centerline, up to 24' AGL/1359' MSL.

Trees, vehicles on road beginning 362' from DER, 4' left of centerline, up to 1414' MSL.

Tree 368' from DER, 524' right of centerline, 48' AGL/1383' MSL.

Trees beginning 370' from DER, 216' right of centerline, up to 1406' MSL.

Trees, vehicles on road beginning 505' from DER, 18' right of centerline, up to 1408' MSL.

Trees, vehicles on road beginning 666' from DER, 80' right of centerline, up to 1412' MSL.

Tree 758' from DER, 457' right of centerline, 1414' MSL.

Trees, vehicles on road, buildings beginning 780' from DER, 4' right of centerline, up to 83' AGL/1426' MSL.

Trees beginning 1456' from DER, 2' left of centerline, up to 76' AGL/1415' MSL.

Trees beginning 1545' from DER, 110' left of centerline, up to 65' AGL/1416' MSL.

Trees beginning 1564' from DER, 180' left of centerline, up to 64' AGL/1418' MSL.

Trees beginning 1575' from DER, 105' left of centerline, up to 70' AGL/1425' MSL.

Trees beginning 1589' from DER, 92' left of centerline, up to 69' AGL/1426' MSL.

Trees beginning 1640' from DER, 101' left of centerline, up to 1430' MSL.

Trees beginning 1667' from DER, 19' left of centerline, up to 1432' MSL.

Trees beginning 1748' from DER, 4' right of centerline, up to 80' AGL/1431' MSL.

Trees beginning 1792' from DER, 50' left of centerline, up to 86' AGL/1434' MSL.

Trees beginning 1808' from DER, 3' left of centerline, up to 1435' MSL.

Trees beginning 1894' from DER, 15' left of centerline, up to 1441' MSL.

Trees beginning 1915' from DER, 1' left of centerline, up to 1442' MSL.

Trees beginning 1974' from DER, 0' left of centerline, up to 1446' MSL.

Trees, pole beginning 1994' from DER, 49' right of centerline, up to 82' AGL/1434' MSL.

Trees beginning 2009' from DER, 3' left of centerline, up to 1448' MSL.

Trees beginning 2016' from DER, 1' right of centerline, up to 92' AGL/1442' MSL.

Trees beginning 2058' from DER, 5' left of centerline, up to 1449' MSL.

Trees beginning 2104' from DER, 51' left of centerline, up to 1454' MSL.

Trees beginning 2110' from DER, 32' left of centerline, up to 1456' MSL.

Trees beginning 2165' from DER, 3' left of centerline, up to 1467' MSL.

Trees beginning 2910' from DER, 211' right of centerline, up to 1445' MSL.

Trees beginning 3288' from DER, 101' right of centerline, up to 83' AGL/1448' MSL.

Trees beginning 4165' from DER, 62' right of centerline, up to 1449' MSL.

Trees beginning 4203' from DER, 115' right of centerline, up to 1456' MSL.

Tree 4245' from DER, 122' right of centerline, 1459' MSL.

Trees beginning 4250' from DER, 28' right of centerline, up to 1463' MSL.

Trees beginning 4610' from DER, 306' right of centerline, up to 1465' MSL.

Trees beginning 4623' from DER, 130' right of centerline, up to 77' AGL/1467' MSL.

Trees beginning 4736' from DER, 52' left of centerline, up to 1477' MSL.

Trees beginning 4832' from DER, 280' right of centerline, up to 1480' MSL.

LUVERNE, MN

QUENTIN AANENSON FLD (LYV)

TAKEOFF MINIMUMS AND (OBSTACLE) DEPARTURE PROCEDURES

ORIG-A 28DEC23 (23362) (FAA)

DEPARTURE PROCEDURE:

Rwy 36, climb on heading 355° to 1900 before turning left.

TAKEOFF OBSTACLE NOTES:

Rwy 18, terrain, vertical point beginning 14' from DER, 7' left of centerline, up to 1429' MSL.

Vertical point 18' from DER, 76' right of centerline, 1429' MSL.

Tree 812' from DER, 576' left of centerline, 1469' MSL.

Rwy 36, terrain point 20' from DER, 77' right of centerline, 1436' MSL.

Tree, vertical beginning 387' from DER, 556' left of centerline, up to 1459' MSL.

Pole, transmission line beginning 5750' from DER, 1049' right of centerline, up to 1583' MSL.

22 FEB 2024 to 21 MAR 2024

22 FEB 2024 to 21 MAR 2024

TAKEOFF MINIMUMS, (OBSTACLE) DEPARTURE PROCEDURES, AND DIVERSE VECTOR AREA (RADAR VECTORS)

24025

NC-1

TAKEOFF MINIMUMS, (OBSTACLE) DEPARTURE PROCEDURES, AND DIVERSE VECTOR AREA (RADAR VECTORS)

24025

MADISON, MN

LAC QUI PARLE COUNTY (DXX)

TAKEOFF MINIMUMS AND (OBSTACLE) DEPARTURE PROCEDURES

ORIG 15NOV12 (12320) (FAA)

TAKEOFF MINIMUMS:

Rwys 9, 27, NA - Environmental.**Rwy 32**, 300-1½ or std. w/min. climb of 213' per NM to 1400, or alternatively, with standard takeoff minimums and a normal 200' per NM climb gradient, takeoff must occur no later than 1500' prior to DER.

TAKEOFF OBSTACLE NOTES:

Rwy 14, trees beginning 40' from DER, 463' right of centerline, up to 100' AGL/1081' MSL.
Terrain 22' from DER, 175' left of centerline, 1080' MSL.**Rwy 32**, vehicles on roadway beginning 538' from DER, left to right of centerline, up to 15' AGL/1098' MSL.

Trees beginning 1485' from DER, 790' left of centerline, up to 100' AGL/1152' MSL.

Tower 1.2 NM from DER, 2112' right of centerline, 200' AGL/1277' MSL.

MADISON, SD

MADISON MUNI (MDS)

TAKEOFF MINIMUMS AND (OBSTACLE) DEPARTURE PROCEDURES

ORIG 30JUN11 (11181) (FAA)

TAKEOFF MINIMUMS:

Rwys 3, 21, NA - environmental.

TAKEOFF OBSTACLE NOTES:

Rwy 15, trees beginning 764' from DER, 284' left of centerline, up to 76' AGL/1766' MSL.

Plant and fence beginning 65' from DER, 384' right of centerline, up to 24' AGL/1733' MSL.

Rwy 33, road 82' from DER, 399' left of centerline, 23' AGL/1723' MSL.

Road and trees beginning 131' from DER, 9' right of centerline, up to 100' AGL/1859' MSL.

MAHONOMEN, MN

MAHONOMEN COUNTY (3N8)

TAKEOFF MINIMUMS AND (OBSTACLE) DEPARTURE PROCEDURES

ORIG 17OCT13 (13290) (FAA)

TAKEOFF MINIMUMS:

Rwys 9, 27, NA-Environmental.

TAKEOFF OBSTACLE NOTES:

Rwy 17, terrain beginning 14' from DER, 402' right of centerline, up to 1248' MSL.**Rwy 35**, vehicles on roadway, poles, and telephone lines beginning 201' from DER, 450' left of centerline, up to 42' AGL/1273' MSL.

Telephone line 972' from DER, 590' right of centerline, 35' AGL/1266' MSL.

Trees beginning 1597' from DER 605' left of centerline, 75' AGL/1306' MSL.

MANDAN, ND

MANDAN RGNL/LAWLER FLD (Y19)

TAKEOFF MINIMUMS AND (OBSTACLE) DEPARTURE PROCEDURES

AMDT 1 29MAY14 (21224) (FAA)

TAKEOFF MINIMUMS:

Rwys 4, 22, NA-Environmental.

TAKEOFF OBSTACLE NOTES:

Rwy 13, fence and trees beginning 26' from DER, 310' left of centerline, up to 48' AGL/1988' MSL.

Transmission lines and pole beginning 1604' from DER, from left to right of centerline, up to 64' AGL/1984' MSL.

Rwy 31, trees beginning 1256' from DER, from left to right of centerline up to 65' AGL/1995' MSL.

MANKATO, MN

MANKATO RGNL (MKT)

TAKEOFF MINIMUMS AND (OBSTACLE) DEPARTURE PROCEDURES

ORIG 24SEP09 (09267) (FAA)

TAKEOFF OBSTACLE NOTES:

Rwy 4, trees beginning 447' from DER, 408' right of centerline, up to 100' AGL/1078' MSL.

Trees beginning 1996' from DER, 17' left of centerline, up to 100' AGL/1084' MSL.

Rwy 15, trees beginning 1552' from DER, 719' left of centerline, up to 100' AGL/1088' MSL.**Rwy 22**, trees beginning 2370' from DER, 989' right of centerline, up to 100' AGL/1069' MSL.**Rwy 33**, trees beginning 2085' from DER, 780' right of centerline, up to 100' AGL/1077' MSL.

Rising terrain 9' from DER, 65' right of centerline, up to 1029' MSL.

Terrain beginning 82' from DER, 60' left of centerline, up to 1029' MSL.

TAKEOFF MINIMUMS, (OBSTACLE) DEPARTURE PROCEDURES, AND DIVERSE VECTOR AREA (RADAR VECTORS)

24025

NC-1

TAKEOFF MINIMUMS, (OBSTACLE) DEPARTURE PROCEDURES, AND DIVERSE VECTOR AREA (RADAR VECTORS)

24025

MARSHALL, MN

SOUTHWEST MINNESOTA RGNL MARSHALL/RYAN FLD (MML)

TAKEOFF MINIMUMS AND (OBSTACLE) DEPARTURE PROCEDURES

AMDT 2A 10DEC15 (21196) (FAA)

TAKEOFF MINIMUMS:

Rwy 20, std. w/min. climb of 270' per NM to 2000, or 1000-3 for climb in visual conditions.

DEPARTURE PROCEDURE:

Rwy 20, for climb in visual conditions, cross Southwest Minnesota Rgnl Marshall/Ryan Fld airport at or above 2000 MSL before proceeding on course.

TAKEOFF OBSTACLE NOTES:

Rwy 2, runway light 39' from DER, 79' left of centerline, 3' AGL/1174' MSL;
Trees beginning 1324' from DER, 796' left of centerline, up to 89' AGL/1256' MSL.
Rwy 12, pole 706' from DER, 671' right of centerline, 60' AGL/1212' MSL.
Pole 1580' from DER, 732' left of centerline, 70' AGL/1225' MSL.
Antenna 1496' from DER, 620' right of centerline, 64' AGL/1219' MSL.
Pole 1185' from DER, 540' right of centerline, 55' AGL/1210' MSL.
Tree 3564' from DER, 400' right of centerline, 110' AGL/1269' MSL.
Tree 2135' from DER, 113' left of centerline, 77' AGL/1232' MSL.
Rwy 20, runway light 42' from DER, 77' left of centerline, 2' AGL, 1183' MSL.
Runway light 41' from DER, 78' right of centerline, 2' AGL/1182' MSL.
Rwy 30, vehicle on road 1' from DER, 435' left of centerline, 24' AGL/1200' MSL.

MARTIN, SD

MARTIN MUNI (9V6)

TAKEOFF MINIMUMS AND (OBSTACLE) DEPARTURE PROCEDURES

ORIG 26MAY16 (16147) (FAA)

TAKEOFF OBSTACLE NOTES:

Rwy 14, lt support structure 9' from DER, 20' left of centerline, 3280' MSL.
Lt support structure 10' from DER, 9' right of centerline, 3278' MSL.
Ground 13' from DER, 408' left of centerline, 3282' MSL.
Ground 27' from DER, 199' left of centerline, 15' AGL/3282' MSL.
Fence and ground beginning 74' from DER, 219' left of centerline, up to 3287' MSL.
Vehicle on road 145' from DER, 289' right of centerline, 15' AGL/3283' MSL.
Rwy 32, building, pole, ground and, vehicle on road, beginning 1' from DER, 9' left of centerline, up to 23' AGL/3317 MSL.
Tree 1083' from DER, 19' left of centerline, 3322' MSL.
Tree 1095' from DER, 387' right of centerline, 3382' MSL.
Tree 1172' from DER, 130' left of centerline, 3340' MSL.
Tree and pole beginning 1270' from DER, 9' left of centerline, up to 3341' MSL.
Tree 1315' from DER, 219' left of centerline, 3343' MSL.
Poles and trees beginning 1366' from DER, 174' left of centerline, up to 44' AGL/3349' MSL.
Trees beginning 1463' from DER, 94' right of centerline, up to 3334' MSL.
Poles and trees beginning 1481' from DER, 406' left of centerline, up to 43' AGL/3350' MSL.

MC GREGOR, MN

ISEDOR IVERSON (HZX)

TAKEOFF MINIMUMS AND (OBSTACLE) DEPARTURE PROCEDURES

ORIG 15DEC11 (11349) (FAA)

DEPARTURE PROCEDURE:

Rwy 14, climb heading 139° to 1900 before turning left.

TAKEOFF OBSTACLE NOTES:

Rwy 14, trees beginning 72' from DER, 440' left of centerline, up to 100' AGL/1324' MSL.
Trees beginning 1158' from DER, 724' right of centerline, up to 100' AGL/1324' MSL.
Trees beginning 2888' from DER, 589' left of centerline, up to 100' AGL/1334' MSL.
Rwy 32, vehicles on roadway beginning 499' from DER, 577' left of centerline, up to 17' AGL/1246' MSL.
Trees beginning 2919' from DER, left and right of centerline, up to 100' AGL/1329' MSL.

MILBANK, SD

MILBANK MUNI (1D1)

TAKEOFF MINIMUMS AND (OBSTACLE) DEPARTURE PROCEDURES

ORIG 10APR08 (08101) (FAA)

TAKEOFF MINIMUMS:

Rwy 25, std. w/min. climb of 207' per NM to 1900, or 900-2½ for climb in visual conditions.

DEPARTURE PROCEDURE:

Rwy 25, for climb in visual conditions cross Milbank Muni airport at or above 1900 before proceeding on course.

TAKEOFF OBSTACLE NOTES:

Rwy 7, trees beginning 1207' from DER, 387' left of centerline, up to 100' AGL/ 1219' MSL.
Vehicle on road 829' from DER, 373' right of centerline, 15' AGL/ 1134' MSL.
Building 322' from DER, 582' right of centerline, 25' AGL/ 1134' MSL.
Rwy 13, trees beginning 1448' from DER, 394' right of centerline, up to 100' AGL/ 1219' MSL.
Vehicle on road 218' from DER, 490' left of centerline, 15' AGL/ 1134' MSL.
Building 78' from DER, 397' left of centerline, 25' AGL/ 1134' MSL.
Rwy 25, tree 3584' from DER, 477' left of centerline, 100' AGL/ 1249' MSL.
Rwy 31, tree 2992' from DER, 715' left of centerline, 100' AGL/ 1239' MSL.

TAKEOFF MINIMUMS, (OBSTACLE) DEPARTURE PROCEDURES, AND DIVERSE VECTOR AREA (RADAR VECTORS)

24025

NC-1

TAKEOFF MINIMUMS, (OBSTACLE) DEPARTURE PROCEDURES, AND DIVERSE VECTOR AREA (RADAR VECTORS)

24025

MILLER, SD

MILLER MUNI (MKA)

TAKEOFF MINIMUMS AND (OBSTACLE) DEPARTURE PROCEDURES

ORIG 25SEP08 (08269) (FAA)

TAKEOFF OBSTACLE NOTES:

- Rwy 15**, vehicle on road 769' from DER, 642' right of centerline, 15' AGL/1599' MSL.
- Snow removal equipment 206' from DER, 475' right of centerline, 21' AGL/1594' MSL.
- Tree 3903' from DER, 998' left of centerline, 100' AGL/1684' MSL.
- Rwy 33**, vehicle on road 450' from DER, 560' left of centerline, 15' AGL/1584' MSL.
- Tree 762' from DER, 628' left of centerline, 100' AGL/1669' MSL.

MINNEAPOLIS, MN

AIRLAKE (LVN)

TAKEOFF MINIMUMS AND (OBSTACLE) DEPARTURE PROCEDURES

ORIG 03JUN10 (10154) (FAA)

TAKEOFF OBSTACLE NOTES:

- Rwy 12**, ground 198' from DER, 533' right of centerline, 0' AGL/963' MSL.
- Tree and vehicle on road, beginning 422' from DER, 379' right of centerline, up to 15' AGL/978' MSL.
- Tree 1291' from DER, 506' left of centerline, 62' AGL/1002' MSL.
- Rwy 30**, ground 104' from DER, 479' left of centerline, 0' AGL/965' MSL.
- Tree, pole, and antenna on building beginning 171' from DER, 259' right of centerline, up to 50' AGL/1000' MSL.
- Tree, railroad, and antenna on building 486' from DER, 268' left of centerline, up to 41' AGL/1001' MSL.
- Trees and a building beginning 821' from DER, 30' right of centerline, up to 49' AGL/1009' MSL.

ANOKA COUNTY/BLAINE (JANES FLD) (ANE)

TAKEOFF MINIMUMS AND (OBSTACLE) DEPARTURE PROCEDURES

AMDT 5B 17AUG17 (22251) (FAA)

TAKEOFF MINIMUMS:

- Rwy 9**, 300-1½ or std. w/min. climb of 205' per NM to 1200, or alternatively, with std. takeoff minimums and a normal 200' per NM climb gradient, takeoff must occur no later than 1200' prior to DER.
- Rwy 18**, 300-1 or std. w/min. climb of 370' per NM to 1200.

DEPARTURE PROCEDURE:

- Rwy 9**, climb heading 089° to 2200 before turning right.
- Rwy 18**, climb heading 179° to 2600 before turning left.
- Rwy 27**, climb heading 269° to 1700 before proceeding southeast bound.
- Rwy 36**, climb heading 359° to 1700 before proceeding southeast bound.

TAKEOFF OBSTACLE NOTES:

- Rwy 9**, tree 821' from DER, 618' right of centerline, 961' MSL.
- Water tank 1.1 NM from DER, 1278' right of centerline, 170' AGL/1082' MSL.
- Rwy 18**, road beginning 2' from DER, 49' right of centerline, up to 925' MSL.
- Trees beginning 405' from DER, 286' left of centerline, up to 946' MSL.
- Trees beginning 487' from DER, 353' left of centerline, up to 954' MSL.
- Tree 757' from DER, 385' left of centerline, 955' MSL.
- Trees beginning 769' from DER, 335' left of centerline, up to 959' MSL.
- Tower 5016' from DER, 200' left of centerline, 120' AGL/1178' MSL.
- Rwy 27**, tree 7' from DER, 270' right of centerline, 908' MSL.
- Trees beginning 70' from DER, 247' right of centerline, up to 912' MSL.
- Tree 185' from DER, 390' right of centerline, 926' MSL.
- Tree 447' from DER, 509' right of centerline, 930' MSL.
- Tree 684' from DER, 671' left of centerline, 946' MSL.
- Tree 1189' from DER, 811' left of centerline, 957' MSL.
- Tree 1296' from DER, 697' right of centerline, 946' MSL.
- Tree 3028' from DER, 553' right of centerline, 983' MSL.
- Rwy 36**, trees beginning 85' from DER, 308' right of centerline, up to 927' MSL.
- Trees beginning 190' from DER, 267' right of centerline, up to 971' MSL.
- Trees beginning 1544' from DER, 249' right of centerline, up to 987' MSL.
- Tree 1985' from DER, 358' left of centerline, 962' MSL.

CRYSTAL (MIC)

TAKEOFF MINIMUMS AND (OBSTACLE) DEPARTURE PROCEDURES

AMDT 4 31DEC20 (20366) (FAA)

TAKEOFF MINIMUMS:

- Rwys 6R, 24L**, NA - Environmental.

DEPARTURE PROCEDURE:

- Rwy 6L**, climb on heading 051° to 2200 before proceeding on course.
- Rwy 14**, climb on heading 139° to 1800 before proceeding on course.

TAKEOFF OBSTACLE NOTES:

- Rwy 6L**, pole 117' from DER, 440' left of centerline, 30' AGL/895' MSL.
- Hanger, tree beginning 241' from DER, 89' left of centerline, up to 40' AGL/906' MSL.
- Trees beginning 466' from DER, 51' left of centerline, up to 948' MSL.
- Tree 746' from DER, 542' right of centerline, 904' MSL.
- Trees beginning 793' from DER, 155' right of centerline, up to 909' MSL.

CON'T

TAKEOFF MINIMUMS, (OBSTACLE) DEPARTURE PROCEDURES, AND DIVERSE VECTOR AREA (RADAR VECTORS)

24025

TAKEOFF MINIMUMS, (OBSTACLE) DEPARTURE PROCEDURES, AND DIVERSE VECTOR AREA (RADAR VECTORS)

24025

MINNEAPOLIS, MN (CON'T)

CRYSTAL (MIC) (CON'T)

Rwy 6L (CON'T), trees beginning 1283' from DER, 412' left of centerline, up to 954' MSL.
Tree 3593' from DER, 382' right of centerline, 968' MSL.

Rwy 14, tree 709' from DER, 550' left of centerline, 917' MSL.
Trees, pole beginning 767' from DER, 335' left of centerline, up to 943' MSL.
Trees beginning 883' from DER, on centerline, up to 940' MSL.
Trees beginning 983' from DER, 7' left of centerline, up to 953' MSL.

Rwy 24R, sign 21' from DER, 138' left of centerline, 2' AGL/870' MSL.
Sign 41' from DER, 131' right of centerline, 3' AGL/872' MSL.
Trees beginning 73' from DER, 498' right of centerline, up to 920' MSL.
Tree, building, beginning 262' from DER, 286' right of centerline, up to 921' MSL.
Vehicles on road 970' from DER, crossing extended runway centerline, 18' AGL/895' MSL.

Rwy 24R (CON'T), tree 1083' from DER, 515' left of centerline, 926' MSL.
Trees beginning 1172' from DER, 216' left of centerline, up to 930' MSL.

Tree 2048' from DER, 497' left of centerline, 962' MSL.
Rwy 32, trees beginning 698' from DER, 11' left of centerline, up to 948' MSL.
Tree 775' from DER, 606' right of centerline, 911' MSL.
Tree 934' from DER, 679' right of centerline, 925' MSL.

Trees, pole beginning 998' from DER, 12' right of centerline, up to 957' MSL.
Trees beginning 1441' from DER, 122' left of centerline, up to 954' MSL.
Trees beginning 1766' from DER, 27' left of centerline, up to 956' MSL.
Trees beginning 1911' from DER, 39' right of centerline, up to 960' MSL.

FLYING CLOUD (FCM)

TAKEOFF MINIMUMS AND (OBSTACLE) DEPARTURE PROCEDURES

AMDT 6 06FEB14 (14037) (FAA)

TAKEOFF OBSTACLE NOTES:

Rwy 10L, tree, buildings, and poles beginning 78' from DER, 346' left of centerline, up to 45' AGL/945' MSL.
Vehicle on road, sign, and trees beginning 645' from DER, 442' right of centerline, up to 37' AGL/937' MSL.
Rwy 10R, buildings beginning 260' from DER, 321' right of centerline, up to 40' AGL/943' MSL.
Trees, poles, and general utility beginning 331' from DER, 106' right of centerline, up to 38' AGL/939' MSL.
Rwy 28R, tree, buildings, and general utility beginning 105' from DER, 353' right of centerline, up to 38' AGL/938' MSL.
Rwy 18, buildings beginning 212' from DER, 318' right of centerline, up to 34' AGL/938' MSL.
Vehicle on road 262' from DER, 195' left of centerline, 15' AGL/918' MSL.
Trees beginning 401' from DER, 165' left of centerline, up to 51' AGL/961' MSL.
Rwy 36, building 3' from DER, 478' left of centerline, 18' AGL/920' MSL.
Trees beginning 426' from DER, 323' right of centerline, up to 61' AGL/951' MSL.
Trees, buildings, poles, and windmill beginning 541' from DER, 302' left of centerline, up to 59' AGL/960' MSL.

MINNEAPOLIS-ST PAUL INTL / WOLD-CHAMBERLAIN (MSP)

TAKEOFF MINIMUMS AND (OBSTACLE) DEPARTURE PROCEDURES

AMDT 12 02MAY13 (13122) (FAA)

TAKEOFF MINIMUMS:

Rwy 12L, 300-1½ or std. w/min. climb of 207' per NM to 1100, or alternatively, with std. takeoff minimums and a normal 200' per NM climb gradient, takeoff must occur no later than 1300' prior to DER.

Rwy 35, std. w/min. climb of 219' per NM to 2100.

DEPARTURE PROCEDURE:

Rwy 4, climb heading 045° to 2100 before turning left.
Rwys 30L, 30R, climb heading 301° to 2100 before turning right.
Rwy 35, climb heading 350° to 2100 before proceeding on course.

TAKEOFF OBSTACLE NOTES:

Rwy 4, trees beginning 800' from DER, 301' left of centerline, up to 75' AGL/925' MSL.
Rod on building 2528' from DER, 1174' left of centerline, 78' AGL/922' MSL.
Fence beginning 13' from DER, 486' left of centerline, up to 6' AGL/860' MSL.
Stack 4535' from DER, 480' left of centerline, 139' AGL/949' MSL.
Rwy 12L, tree 1.1 NM from DER, 1691' left of centerline, 92' AGL/991' MSL.
Light pole and camera on wall beginning 398' from DER, 561' right of centerline, up to 23' AGL/832' MSL.
Rwy 12R, tree 1479' from DER, 561' left of centerline, 86' AGL/855' MSL.
Obstruction light on pole 1002' from DER, 753' left of centerline, 53' AGL/852' MSL.
Rwy 17, pole 409' from DER, 530' right of centerline, 29' AGL/866' MSL.
Building 2619' from DER, 881' left of centerline, 97' AGL/918' MSL.
Building 1956' from DER, 904' left of centerline, 61' AGL/866' MSL.
Tree 2619' from DER, on centerline, 79' AGL/900' MSL.
Rwy 22, trees beginning 2659' from DER, 867' right of centerline, 94' AGL/934' MSL.
Rwy 30L, antenna on tower 3555' from DER, 1334' left of centerline, 116' AGL/935' MSL.
Rwy 30R, billboard sign 1463' from DER, 848' right of centerline, 31' AGL/880' MSL.
Rwy 35, trees beginning 2553' from DER, 770' right of centerline, 100' AGL/919' MSL.
Trees beginning 1989' from DER, 194' left of centerline, up to 87' AGL/906' MSL.
Buildings beginning 5.4 NM from DER, 1781' left of centerline, up to 889' AGL/1743' MSL.

22 FEB 2024 to 21 MAR 2024

22 FEB 2024 to 21 MAR 2024

TAKEOFF MINIMUMS, (OBSTACLE) DEPARTURE PROCEDURES, AND DIVERSE VECTOR AREA (RADAR VECTORS)

24025

NC-1

TAKEOFF MINIMUMS, (OBSTACLE) DEPARTURE PROCEDURES, AND DIVERSE VECTOR AREA (RADAR VECTORS)

24025

MINOT, ND

MINOT INTL (MOT)

TAKEOFF MINIMUMS AND (OBSTACLE) DEPARTURE PROCEDURES

AMDT 3A 07APR11 (11097) (FAA)

TAKEOFF MINIMUMS:

Rwy 26, 300-1½ or std. with a min. climb of 219' per NM to 2000.

DEPARTURE PROCEDURE:

Rwy 13, climb via heading 128° to 2200 before turning right.

Rwy 26, climb via heading 260° to 2300 before turning left.

TAKEOFF OBSTACLE NOTES:

Rwy 8, fence 261' from DER, 415' right of centerline, 9' AGL/1669' MSL.

Rwy 26, poles beginning 952' from DER, 523' left of centerline, up to 42' AGL/1761' MSL.

Tower 1297' from DER, 405' right of centerline, 29' AGL/1751' MSL.

Sign 1372' from DER, 323' left of centerline, 31' AGL/1750' MSL.

Sign 1377' from DER, 832' right of centerline, 59' AGL/1778' MSL.

Light pole 1419' from DER, 24' right of centerline, 36' AGL/1752' MSL.

Trees beginning 1463' from DER, 73' right of centerline, up to 76' AGL/1795' MSL.

Building 1432' from DER, 303' right of centerline, 33' AGL/1753' MSL.

Tree 2071' from DER, 60' left of centerline, 53' AGL/1772' MSL.

Tank 1.1 NM from DER, 1812' right of centerline, 140' AGL/1900' MSL.

Rwy 31, trees beginning 2908' from DER, 560' left of centerline, up to 64' AGL/1778' MSL.

MITCHELL, SD

MITCHELL MUNI (MHE)

TAKEOFF MINIMUMS AND (OBSTACLE) DEPARTURE PROCEDURES

AMDT 1A 10DEC15 (15344) (FAA)

TAKEOFF OBSTACLE NOTES:

Rwy 18, trees beginning 829' from DER, 505' right of centerline, up to 80' AGL/1386' MSL.

NAVAID 119' from DER, 409' left of centerline, 9' AGL/1308' MSL.

Rwy 36, trees beginning 552' from DER, 575' right of centerline, up to 80' AGL/1328' MSL.

NAVAIDS beginning 34' from DER, 100' right and left of centerline, up to 3' AGL/1286' MSL.

MOBRIDGE, SD

MOBRIDGE MUNI(MBG)

TAKEOFF MINIMUMS AND (OBSTACLE) DEPARTURE PROCEDURES

AMDT 1 30JUN11 (11181) (FAA)

TAKEOFF MINIMUMS:

Rwys 17, 35, NA-Environmental

DEPARTURE PROCEDURE:

Rwy 12, climb heading 118° to 2600 before turning left.

TAKEOFF OBSTACLE NOTES:

Rwy 12, tower 2587' from DER, 651' right of centerline, 40' AGL/ 1810' MSL.

Pole 3567' from DER, 12' right of centerline, 11' AGL/ 1790' MSL.

Tree 1495' from DER, 230' right of centerline, 29' AGL/ 1738' MSL.

Trees and poles beginning 1698' from DER, 160' left of centerline, up to 75' AGL/ 1811' MSL.

Terrain and road beginning 153' from DER, 307' left of centerline, up to 17' AGL/1749' MSL.

Rwy 30, terrain and road beginning 36' from DER, left to right across centerline, up to 17' AGL/1710' MSL.

MOHALL, ND

MOHALL MUNI (HBC)

TAKEOFF MINIMUMS AND (OBSTACLE) DEPARTURE PROCEDURES

AMDT 1 03NOV22 (23054) (FAA)

TAKEOFF OBSTACLE NOTES:

Rwy 13, pole, vehicle on road beginning 42' from DER, 232' right of centerline, up to 19' AGL/1668' MSL.

Tree 761' from DER, 241' left of centerline, 1670' MSL.

Rwy 31, transmission line 1650' from DER, 941' right of centerline, 52' AGL/1701' MSL.

Transmission line, electrical system beginning 1866' from DER, 685' right of centerline, up to 52' AGL/1704' MSL.

Transmission line 2255' from DER, 224' right of centerline, 52' AGL/1706' MSL.

MONTEVIDEO, MN

MONTEVIDEO-CHIPPEWA COUNTY (MVE)

TAKEOFF MINIMUMS AND (OBSTACLE) DEPARTURE PROCEDURES

ORIG-A 20AUG15 (15232) (FAA)

TAKEOFF MINIMUMS:

Rwy 3, 21, NA-Environmental.

DEPARTURE PROCEDURE:

Rwy 14, climb runway heading to 1500 before turning.

TAKEOFF MINIMUMS, (OBSTACLE) DEPARTURE PROCEDURES, AND DIVERSE VECTOR AREA (RADAR VECTORS)

24025

TAKEOFF MINIMUMS, (OBSTACLE) DEPARTURE PROCEDURES, AND DIVERSE VECTOR AREA (RADAR VECTORS)

24025

MOORHEAD, MN

MOORHEAD MUNI/FLORENCE KLINGENSMITH FLD (JKJ)
TAKEOFF MINIMUMS AND (OBSTACLE) DEPARTURE PROCEDURES
ORIG 20OCT11 (22139) (FAA)

TAKEOFF OBSTACLE NOTES:

- Rwy 12, building 263' from DER, 495' left of centerline, 15' AGL/932' MSL.
- Tree 657' from DER, 449' left of centerline, 114' AGL/1031' MSL.
- Trees 1463' from DER, 711' left of centerline, up to 69' AGL/986' MSL.
- Poles beginning 868' from DER, left and right of centerline, up to 48' AGL/965' MSL.
- Rwy 30, tree 119' from DER, 104' left of centerline, 4' AGL/918' MSL.
- Poles beginning 1342' from DER, 855' right of centerline, up to 55' AGL/969' MSL.

MOOSE LAKE, MN

MOOSE LAKE CARLTON COUNTY (MZH)
TAKEOFF MINIMUMS AND (OBSTACLE) DEPARTURE PROCEDURES
ORIG 06JAN94 (94006) (FAA)

TAKEOFF MINIMUMS:

- Rwys 4, 22, 300-1.

MORA, MN

MORA MUNI (JMR)
TAKEOFF MINIMUMS AND (OBSTACLE) DEPARTURE PROCEDURES
ORIG-A 24MAY18 (18144) (FAA)

TAKEOFF MINIMUMS:

- Rwys 11, 29, NA - environmental.

TAKEOFF OBSTACLE NOTES:

- Rwy 17, light pole 16' from DER, 17' right of centerline, 3' AGL/1012' MSL.
- Terrain 27' from DER, 311' from DER, 1012' MSL.
- Vehicle on road, building, and trees beginning 162' from DER, 410' right of centerline, up to 33' AGL/1034' MSL.
- Trees beginning 208' from DER, 443' left of centerline, up to 44' AGL/1045' MSL.
- Trees beginning 644' from DER, 455' right of centerline, up to 53' AGL/1054' MSL.
- Trees beginning 864' from DER, 178' right of centerline, up to 76' AGL/1068' MSL.
- Trees beginning 1055' from DER, 37' left of centerline, up to 62' AGL/1063' MSL.
- Trees beginning 1619' from DER, 491' right of centerline, up to 72' AGL/1074' MSL.
- Tree 1975' from DER, 405' left of centerline, 68' AGL/1069' MSL.
- Tree 2054' from DER, 2' right of centerline, 68' AGL/1069' MSL.
- Trees beginning 2237' from DER, crossing centerline, up to 88' AGL/1089' MSL.
- Trees beginning 2645' from DER, 777' right of centerline, up to 89' AGL/1105' MSL.
- Rwy 35, terrain beginning 168' from DER, 290' left of centerline, up to 1018' MSL.
- Terrain 178' from DER, 383' right of centerline, 1005' MSL.
- Terrain, vehicle on road, and trees beginning 349' from DER, 387' right of centerline, up to 58' AGL/1059' MSL.
- Trees beginning 441' from DER, 388' left of centerline, up to 46' AGL/1057' MSL.
- Trees beginning 634' from DER, 354' left of centerline, up to 70' AGL/1071' MSL.
- Trees beginning 617' from DER, 427' right of centerline, up to 66' AGL/1067' MSL.
- Trees beginning 1032' from DER, 267' left of centerline, up to 68' AGL/1086' MSL.
- Trees beginning 1563' from DER, 582' right of centerline, up to 61' AGL/1072' MSL.
- Tree 1791' from DER, 964' left of centerline, 66' AGL/1097' MSL.
- Trees beginning 2085' from DER, crossing centerline, up to 73' AGL/1104' MSL.

MORRIS, MN

MORRIS MUNI/CHARLIE SCHMIDT FLD (MOX)
TAKEOFF MINIMUMS AND (OBSTACLE) DEPARTURE PROCEDURES
AMDT 1 08SEP22 (22251) (FAA)

TAKEOFF MINIMUMS:

- Rwys 4, 22, NA-Environmental.

TAKEOFF OBSTACLE NOTES:

- Rwy 32, lighting 6' from DER, 113' left of centerline, 2' AGL/1128' MSL.
- General utility, lighting beginning 7' from DER, 17' left of centerline, up to 3' AGL/1129' MSL.
- General utility 7' from DER, 112' right of centerline, 4' AGL/1130' MSL.
- Sign, terrain beginning 8' from DER, 312' right of centerline, up to 3' AGL/1132' MSL.
- Pole, traverse way beginning 275' from DER, 513' right of centerline, up to 31' AGL/1163' MSL.
- Tree 615' from DER, 643' left of centerline, 1143' MSL.

NEW TOWN, ND

NEW TOWN MUNI (05D)
TAKEOFF MINIMUMS AND (OBSTACLE) DEPARTURE PROCEDURES
ORIG 31DEC20 (23110) (FAA-O)

TAKEOFF OBSTACLE NOTES:

- Rwy 12, trees 329' from DER, 267' right of centerline, up to 50' AGL/1979' MSL.
- Trees 1113' from DER, 655' left of centerline, up to 50' AGL/1989' MSL.
- Rwy 30, pole, tower and transmission lines beginning 1790' from DER, 366' right of centerline, up to 129' AGL/2027' MSL.

TAKEOFF MINIMUMS, (OBSTACLE) DEPARTURE PROCEDURES, AND DIVERSE VECTOR AREA (RADAR VECTORS)

24025

NC-1

TAKEOFF MINIMUMS, (OBSTACLE) DEPARTURE PROCEDURES, AND DIVERSE VECTOR AREA (RADAR VECTORS)

24025

NEW ULM, MN

NEW ULM MUNI (ULM)

TAKEOFF MINIMUMS AND (OBSTACLE) DEPARTURE PROCEDURES

ORIG-A 17SEP15 (15260) (FAA)

TAKEOFF MINIMUMS:

Rwy 4, 22, NA-Environmental.

TAKEOFF OBSTACLE NOTES:

Rwy 33, tree 628' from DER, 417' right of centerline, 33' AGL/1034' MSL.

Tree 1457' from DER, 650' left of centerline, 38' AGL/1047' MSL.

Ground 4' from DER, 154' left of centerline, 1007' MSL.

Rwy 15, tree 1935' from DER, 610' left of centerline, 100' AGL/1099' MSL.

NORTHWOOD, ND

NORTHWOOD MUNI/VINCE FLD (4V4)

TAKEOFF MINIMUMS AND (OBSTACLE) DEPARTURE PROCEDURES

ORIG 09FEB12 (21336) (FAA)

TAKEOFF OBSTACLE NOTES:

Rwy 8, trees beginning 3317' from DER, 737' left of centerline, up to 100' AGL/1214' MSL.**Rwy 26**, trees beginning 1171' from DER, left and right of centerline, up to 100' AGL/1214' MSL.

OAKES, ND

OAKES MUNI (2D5)

TAKEOFF MINIMUMS AND (OBSTACLE) DEPARTURE PROCEDURES

AMDT 1A 26APR18 (18116) (FAA)

TAKEOFF MINIMUMS:

Rwys 17, 35, NA - Environmental.

TAKEOFF OBSTACLE NOTES:

Rwy 12, trees beginning 2071' from DER, left and right of centerline, up to 100' AGL/1459' MSL.**Rwy 30**, trees beginning 2509' from DER, 744' left of centerline, up to 100' AGL/1454' MSL.

OLIVIA, MN

OLIVIA RGNL (OVL)

TAKEOFF MINIMUMS AND (OBSTACLE) DEPARTURE PROCEDURES

AMDT 1 13FEB86 (86044) (FAA)

TAKEOFF MINIMUMS:

Rwy 11, 300-1.

ONIDA, SD

ONIDA MUNI (98D)

TAKEOFF MINIMUMS AND (OBSTACLE) DEPARTURE PROCEDURES

ORIG 01FEB18 (18032) (FAA)

TAKEOFF MINIMUMS:

Rwy 8, 26, NA - environmental.**Rwy 13**, 300-1½ or std. w/min. climb gradient of 250 feet per NM to 2500.

TAKEOFF OBSTACLE NOTES:

Rwy 13, light pole 10' from DER, 10' left of centerline, 2' AGL/1887' MSL.

Light pole 10' from DER, 10' right of centerline, 3' AGL/1887' MSL.

Rwy 31, light pole 11' from DER, 10' right of centerline, 3' AGL/1864' MSL.

Light pole 11' from DER, 11' left of centerline, 3' AGL/1863' MSL.

ORR, MN

ORR RGNL (ORB)

TAKEOFF MINIMUMS AND (OBSTACLE) DEPARTURE PROCEDURES

AMDT 2 31MAY12 (12152) (FAA)

TAKEOFF MINIMUMS:

Rwy 13, 300-1½ or std. w/ min. climb of 260' per NM to 1600.

DEPARTURE PROCEDURE:

Rwy 13, climb heading 136° to 1900 before turning right.

TAKEOFF OBSTACLE NOTES:

Rwy 13, trees beginning 630' from DER, 476' right of centerline, up to 80' AGL/1389' MSL.

Trees beginning 759' from DER, 361' left of centerline, up to 80' AGL/1459' MSL.

Trees beginning 1.1 NM from DER, 1343' right of centerline, up to 80' AGL/1499' MSL.

Rwy 31, trees beginning 366' from DER, 162' left of centerline, up to 80' AGL/429' MSL.

Trees beginning 867' from DER, 719' right of centerline, up to 80' AGL/1429' MSL.

Trees beginning 5401' from DER, 148' right of centerline, up to 80' AGL/1449' MSL.

TAKEOFF MINIMUMS, (OBSTACLE) DEPARTURE PROCEDURES, AND DIVERSE VECTOR AREA (RADAR VECTORS)

24025

NC-1

TAKEOFF MINIMUMS, (OBSTACLE) DEPARTURE PROCEDURES, AND DIVERSE VECTOR AREA (RADAR VECTORS)

24025

ORTONVILLE, MN

ORTONVILLE MUNI/MARTINSON FLD (VVV)

TAKEOFF MINIMUMS AND (OBSTACLE) DEPARTURE PROCEDURES

ORIG 01OCT81 (22251) (FAA)

TAKEOFF MINIMUMS:

Rwy 16, 300-1 or std. w/min. climb of 210' per NM to 1300.

OWATONNA, MN

OWATONNA DEGNER RGNL (OWA)

TAKEOFF MINIMUMS AND (OBSTACLE) DEPARTURE PROCEDURES

AMDT 2 30JAN97 (97030) (FAA)

DEPARTURE PROCEDURE:

Rwy 12, climb runway heading to 1500 before turning on course.

PARK RAPIDS, MN

PARK RAPIDS MUNI/KONSHOK FLD (PKD)

TAKEOFF MINIMUMS AND (OBSTACLE) DEPARTURE PROCEDURES

AMDT 1 23JUN16 (22027) (FAA)

DEPARTURE PROCEDURE:

Rwy 36, climb heading 356° to 2000 before turning right.

TAKEOFF OBSTACLE NOTES:

Rwy 13, pole 880' from DER, 711' left of centerline, 26' AGL/1467' MSL.

Rwy 18, trees beginning 1371' from DER, left and right of centerline, up to 1549' MSL.

Trees beginning 3080' from DER, left and right of centerline, up to 1539' MSL.

Rwy 31, vehicles on road beginning 66' from DER, right and left of centerline, up to 1462' MSL.

Trees beginning 359' from DER, 454' right of centerline, up to 1468' MSL.

Trees beginning 799' from DER, 236' left of centerline, up to 1479' MSL.

Trees beginning 854' from DER, 296' right of centerline, up to 1476' MSL.

Rwy 36, trees and buildings beginning 575' from DER, left and right of centerline, up to 1549' MSL.

Trees beginning 2802' from DER, 95' right of centerline, up to 1559' MSL.

PARKSTON, SD

PARKSTON MUNI (8V3)

TAKEOFF MINIMUMS AND (OBSTACLE) DEPARTURE PROCEDURES

ORIG 17OCT13 (13290) (FAA)

TAKEOFF OBSTACLE NOTES:

Rwy 15, poles beginning 628' from DER, left and right of centerline, up to 37' AGL/1452' MSL.

Transmission towers beginning 758' from DER, left and right of centerline, up to 29' AGL/1444' MSL.

Train on railroad, 777' from DER, 573' left of centerline, 24' AGL/1439' MSL.

Building 1189' from DER, 694' left of centerline, 35' AGL/1450' MSL.

Trees beginning 1227' from DER, 268' left of centerline, up to 36' AGL/1459' MSL.

Rwy 33, trees beginning 300' from DER, left and right of centerline, up to 63' AGL/1478' MSL.

Poles beginning 662' from DER, left and right of centerline, up to 48' AGL/1463' MSL.

Transmission towers beginning 896' from DER, left and right of centerline, up to 44' AGL/1459' MSL.

Lighted support structures beginning 1076' from DER, left and right of centerline, up to 48' AGL/1463' MSL.

Fences beginning 17' from DER, left and right of centerline, up to 6' AGL/1421' MSL.

Silo, 1677' from DER, 43' AGL/1458' MSL. Vehicle on road, 54' from DER, 14' AGL/1459' MSL.

PAYNESVILLE, MN

PAYNESVILLE MUNI (PEX)

TAKEOFF MINIMUMS AND (OBSTACLE) DEPARTURE PROCEDURES

AMDT 1 08NOV18 (18312) (FAA)

TAKEOFF MINIMUMS:

Rwy 11, 300-1½ or std. w/min. climb of 234' per NM to 1600.

Rwy 29, 300-1¼ or std. w/min. climb of 210' per NM to 1500.

TAKEOFF OBSTACLE NOTES:

Rwy 11, trees beginning 61' from DER, 482' right of centerline, up to 1231' MSL.

Tree 3539' from DER, 1234' right of centerline, 1309' MSL.

Tower 1.5 NM from DER, 1956' left of centerline, 184' AGL/1456' MSL.

Tower 1.5 NM from DER, 1318' left of centerline, 193' AGL/1458' MSL.

Rwy 29, tree 1951' from DER, 990' right of centerline, 1240' MSL.

Power lines 1.3 NM from DER, 2625' left of centerline, 200' AGL/1399' MSL.

PEMBINA, ND

PEMBINA MUNI (PMB)

TAKEOFF MINIMUMS AND (OBSTACLE) DEPARTURE PROCEDURES

ORIG 21NOV85 (85325) (FAA)

DEPARTURE PROCEDURE:

Rwy 33, climb runway heading 3200 before turning left.

TAKEOFF MINIMUMS, (OBSTACLE) DEPARTURE PROCEDURES, AND DIVERSE VECTOR AREA (RADAR VECTORS)

24025

TAKEOFF MINIMUMS, (OBSTACLE) DEPARTURE PROCEDURES, AND DIVERSE VECTOR AREA (RADAR VECTORS)

24025

PERHAM, MN

PERHAM MUNI (16D)

TAKEOFF MINIMUMS AND (OBSTACLE) DEPARTURE PROCEDURES

AMDT 1 22AUG13 (13234) (FAA)

DEPARTURE PROCEDURE:

Rwy 13, climb heading 128° to 1900 before turning left.

TAKEOFF OBSTACLE NOTES:

Rwy 13, REILs 8' from DER, 79' right of centerline, 2' AGL/1373' MSL.

Trees beginning 6' from DER, 350' right of centerline, up to 50' AGL/1386' MSL and trees beginning 138' from DER, 115' right of centerline, up to 50' AGL/1433' MSL.

Light 8' from DER, 79' left of centerline, 2' AGL/1373' MSL.

Trees beginning 261' from DER, 251' left of centerline, up to 50' AGL/1387' MSL.

Rwy 31, REILs 9' from DER, 79' right of centerline, 2' AGL/1378' MSL.

Ground 8' from DER, 223' right of centerline, 1377' MSL.

Poles and tower beginning 627' from DER, 570' right of centerline, up to 43' AGL/1430' MSL.

Light, 8' from DER, 79' left of centerline, 2' AGL/1377' MSL.

Vehicles on road beginning 431' from DER, 32' left of centerline, up to 18' AGL/1394' MSL.

Trees, pole, and building beginning 93' from DER, 377' left of centerline, up to 50' AGL/1409' MSL.

PHILIP, SD

PHILIP (PHP)

TAKEOFF MINIMUMS AND (OBSTACLE) DEPARTURE PROCEDURES

ORIG 06FEB14 (14037) (FAA)

TAKEOFF MINIMUMS:

Rwys 5, 23, NA-Environmental.

TAKEOFF OBSTACLE NOTES:

Rwy 12, tree and fence beginning 2' from DER, 334' right of centerline, up to 25' AGL/2204' MSL.

Sign, fence and trees beginning 27' from DER, 127' left of centerline, up to 30' AGL/2212' MSL.

Rwy 30, fence beginning 174' from DER, 286' left of centerline, up to 10' AGL/2219' MSL.

Fence and vehicles on road beginning 3' from DER, 448' right of centerline, up to 15' AGL/2219' MSL.

Poles beginning 950' from DER, 308' right of centerline, up to 36' AGL/2250' MSL.

Terrain beginning 2598' from DER, 251' right of centerline, up to 2277' MSL.

Road beginning 4019' from DER, 1413' right of centerline, up to 15' AGL/2322' MSL.

PIERRE, SD

PIERRE RGNL (PIR)

TAKEOFF MINIMUMS AND (OBSTACLE) DEPARTURE PROCEDURES

AMDT 2 25APR85 (85115) (FAA)

TAKEOFF MINIMUMS:

Rwy 25, 300-1.

PINE RIDGE, SD

PINE RIDGE (IEN)

TAKEOFF MINIMUMS AND (OBSTACLE) DEPARTURE PROCEDURES

AMDT 1 26JUL12 (12208) (FAA)

TAKEOFF MINIMUMS:

Rwy 6, 24, NA- closed indefinitely.**Rwy 12**, 300-1 or std. w/min. climb of 450' per NM to 3700.**Rwy 30**, 300-1 or std. w/min. climb of 407' per NM to 3600.

TAKEOFF OBSTACLE NOTES:

Rwy 12, vehicle on road 10' from DER, left to right of centerline, 15' AGL/3347' MSL.

Fence 200' from DER, 350' right of centerline, 10' AGL/3338' MSL.

Rwy 30, tree 638' from DER, 492' right of centerline, 50' AGL/3339' MSL.

Vehicle on road 10' from DER, right of centerline, 15' AGL/3316' MSL.

Vehicle on road 407' from DER, right to left of centerline, 15' AGL/3313' MSL.

PINECREEK, MN

PINEY PINECREEK BORDER (48Y)

TAKEOFF MINIMUMS AND (OBSTACLE) DEPARTURE PROCEDURES

ORIG 15NOV12 (12320) (FAA)

TAKEOFF OBSTACLE NOTES:

Rwy 15, poles beginning 459' from DER, 415' left of centerline, up to 32' AGL/1092' MSL.

Airfield light 8' from DER, 45' right of centerline, 8' AGL/1068' MSL.

Vehicle on road 900' from DER, left and right of centerline, 15' AGL/1078' MSL.

Rwy 33, trees beginning 11' from DER, 47' left of centerline, up to 100' AGL/1084' MSL.

Trees beginning 167' from DER, 406' right of centerline, up to 100' AGL/1101' MSL.

TAKEOFF MINIMUMS, (OBSTACLE) DEPARTURE PROCEDURES, AND DIVERSE VECTOR AREA (RADAR VECTORS)

24025

TAKEOFF MINIMUMS, (OBSTACLE) DEPARTURE PROCEDURES, AND DIVERSE VECTOR AREA (RADAR VECTORS)

24025

PINE RIVER, MN

PINE RIVER RGNL (PWC)

TAKEOFF MINIMUMS AND (OBSTACLE) DEPARTURE PROCEDURES

ORIG 08MAR12 (12068) (FAA)

TAKEOFF MINIMUMS:

Rwy 16, 300-1¼ or std. w/min. climb gradient of 218' per NM to 1500.

DEPARTURE PROCEDURE:

Rwy 16, climb heading 160° to 1800 before turning right.

TAKEOFF OBSTACLE NOTES:

Rwy 16, trees 2' from DER, 181' right of centerline, up to 5' AGL/1296' MSL.

Trees beginning 10' from DER, 113' left of centerline, up to 67' AGL/1366' MSL.

Road beginning 63' from DER, 381' right of centerline, up to 15' AGL/1310' MSL.

Poles beginning 611' from DER, 424' right of centerline, 26' AGL/1325' MSL.

REIL 50' from DER, 76' right of centerline, 7' AGL/1298' MSL.

Trees beginning 1267' from DER, 15' right of centerline, up to 100' AGL/1449' MSL.

Rwy 34, trees beginning 13' from DER, 121' right of centerline, up to 65' AGL/1374' MSL.

Trees beginning 1059' from DER, left and right of centerline, up to 101' AGL/1400' MSL.

REIL 50' from DER, 77' left of centerline, 7' AGL/1298' MSL.

Poles beginning 522' from DER, 520' left of centerline, up to 35' AGL/1334' MSL.

Buildings beginning 373' from DER, 465' left of centerline, up to 18' AGL/1327' MSL.

PIPESTONE, MN

PIPESTONE MUNI (PQN)

TAKEOFF MINIMUMS AND (OBSTACLE) DEPARTURE PROCEDURES

ORIG 14FEB08 (08045) (FAA)

TAKEOFF MINIMUMS:

Rwys 9,27, NA-Environmental.

TAKEOFF OBSTACLE NOTES:

Rwy 18, Trees beginning 3811' from DER, 854' right of centerline, up to 100' AGL/1859' MSL.

PRESTON, MN

FILLMORE COUNTY (FKA)

TAKEOFF MINIMUMS AND (OBSTACLE) DEPARTURE PROCEDURES

ORIG 23APR98 (98113) (FAA)

TAKEOFF MINIMUMS:

Rwys 11,29, 300-1.

PRINCETON, MN

PRINCETON MUNI (PNM)

TAKEOFF MINIMUMS AND (OBSTACLE) DEPARTURE PROCEDURES

AMDT 1A 31DEC20 (20366) (FAA)

TAKEOFF OBSTACLE NOTES:

Rwy 16, vehicles on road abeam DER, 149' left of centerline, 992' MSL.

Sign, terrain beginning 20' from DER, 216' right of centerline, up to 987' MSL.

Trees, vehicles on road beginning 141' from DER, 150' left of centerline, up to 1000' MSL.

Antenna 332' from DER, 558' right of centerline, 42' AGL/1022' MSL.

Tower, vehicles on road, building, trees beginning 335' from DER, 264' right of centerline, up to 50' AGL/1024' MSL.

Trees beginning 460' from DER, 433' left of centerline, up to 29' AGL/1007' MSL.

Trees beginning 841' from DER, 94' right of centerline, up to 1027' MSL.

Tree 1482' from DER, 86' left of centerline, 1021' MSL.

Tree 2085' from DER, 220' left of centerline, 1039' MSL.

Tree 2107' from DER, 458' right of centerline, 1042' MSL.

Trees beginning 2199' from DER, 123' left of centerline, up to 1040' MSL.

Rwy 34, trees beginning 31' from DER, 273' left of centerline, up to 52' AGL/1032' MSL.

Trees beginning 196' from DER, 32' left of centerline, up to 64' AGL/1044' MSL.

Tree 1218' from DER, 409' right of centerline, 1037' MSL.

Tree 1223' from DER, 652' right of centerline, 1039' MSL.

Tree 1391' from DER, 693' right of centerline, 59' AGL/1047' MSL.

Trees beginning 1477' from DER, 482' right of centerline, up to 80' AGL/1066' MSL.

Trees beginning 1663' from DER, 30' right of centerline, up to 1071' MSL.

Trees beginning 2001' from DER, 113' left of centerline, up to 1056' MSL.

22 FEB 2024 to 21 MAR 2024

22 FEB 2024 to 21 MAR 2024

TAKEOFF MINIMUMS, (OBSTACLE) DEPARTURE PROCEDURES, AND DIVERSE VECTOR AREA (RADAR VECTORS)

24025

TAKEOFF MINIMUMS, (OBSTACLE) DEPARTURE PROCEDURES, AND DIVERSE VECTOR AREA (RADAR VECTORS)

24025

RAPID CITY, SD

RAPID CITY RGNL (RAP)

TAKEOFF MINIMUMS AND (OBSTACLE) DEPARTURE PROCEDURES

AMDT 7 10MAR11 (11069) (FAA)

DEPARTURE PROCEDURE:

Rwy 5, climb on heading between 255° CW to 210° from DER, or min. climb of 240' per NM to 8800 for all other courses.

Rwy 14, climb on heading between 325° CW to 210° from DER, or min. climb of 245' per NM to 8900 for all other courses.

Rwy 23, climb on heading between 210° CCW to 055° from DER, or min. climb of 245' per NM to 8900 for all other courses.

Rwy 32, climb on heading 324° to 3700 for courses between 255° CW to 140° from DER, or min. climb of 244' per NM to 8800 for all other courses.

TAKEOFF OBSTACLE NOTES:

Rwy 5, fence 132' from DER, 249' left of centerline, up to 13' AGL/3215' MSL.

Trees beginning 16' from DER, 188' right of centerline, up to 25' AGL/3234' MSL.

Trees beginning 11' from DER, 111' left of centerline, up to 25' AGL/3234' MSL.

Rwy 14, trees beginning 136' from DER, 123' right of centerline, up to 25' AGL/3174' MSL.

Trees beginning 33' from DER, 229' left of centerline, up to 25' AGL/3164' MSL.

Rwy 23, vehicle on road 36' from DER, 121' left of centerline, up to 15' AGL/3175' MSL.

Hanger 201' from DER, 298' left of centerline, up to 30' AGL/3193' MSL.

Fence 333' from DER, 255' right of centerline, up to 14' AGL/3184' MSL.

Trees beginning 199' from DER, 175' right of centerline, up to 25' AGL/3194' MSL.

Trees beginning 158' from DER, 159' left of centerline, up to 25' AGL/3194' MSL.

Rwy 32, fence 1001' from DER, 750' right of centerline, up to 13' AGL/3233' MSL.

Obstruction light 661' from DER, 242' left of centerline, up to 43' AGL/3213' MSL.

Trees beginning 31' from DER, 262' right of centerline, up to 25' AGL/3254' MSL.

Trees beginning 61' from DER, 146' left of centerline, up to 25' AGL/3204' MSL.

DIVERSE VECTOR AREA (RADAR VECTORS)

ORIG 12OCT17 (17285) (FAA)

Rwy 32, heading as assigned by ATC.

RAY S. MILLER AAF (KRYM)

CAMP RIPLEY, MN

TAKEOFF MINIMUMS AND (OBSTACLE) DEPARTURE PROCEDURES

AMDT 3 05OCT23 (23278) (USA)

TAKEOFF MINIMUMS:

Rwy 31, 300-1 or std w/min climb of 552'/NM to 1600.

TAKEOFF OBSTACLES:

Rwy 13, terrain 73' from DER, 8' left and right of centerline, 1270' MSL.

Vehicle 765' from DER, 638' left of centerline, 15' AGL/1180' MSL.

Tree 1500' from DER, 152' left of centerline, 1183' MSL.

Tree 929' from DER, 677' left of centerline, 1182' MSL.

Tree 1352' from DER, 194' left of centerline, 1178' MSL.

Terrain at DER, 500' right of centerline, 1162' MSL.

Terrain 444' from DER, 619' right of centerline, 1162' MSL.

Rwy 31, terrain 54' from DER, 9' left and right of centerline, 1273' MSL.

Trees 798' from DER, 325' left and right of centerline, 64' AGL/1282' MSL.

Tree 2185' from DER, 1002' left of centerline, 1304' MSL.

Tree 3702' from DER, 1153' right of centerline, 1284' MSL.

Tree 3709' from DER, 800' left of centerline, 1282' MSL.

Tree 2728' from DER, 901' right of centerline, 1280' MSL.

Tree 2181' from DER, 539' right of centerline, 1276' MSL.

Tree 4673' from DER, 762' left of centerline, 1273' MSL.

Tree 3899' from DER, 1182' right of centerline, 1267' MSL.

Tree 2064' from DER, 804' right of centerline, 1267' MSL.

Tree 4454' from DER, 178' left of centerline, 1264' MSL.

Tree 1463' from DER, 737' right of centerline, 1224' MSL.

RED WING, MN

RED WING RGNL (RGK)

TAKEOFF MINIMUMS AND (OBSTACLE) DEPARTURE PROCEDURES

AMDT 2A 13SEP18 (18256) (FAA)

TAKEOFF MINIMUMS:

Rwy 9, std. w/min. climb of 339' per NM to 1700.

TAKEOFF OBSTACLE NOTES:

Rwy 9, NAVAID 51' from DER, 75' left of centerline, 14' AGL/778' MSL.

Trees beginning 273' from DER, 457' left of centerline, up to 787' MSL.

Tree 523' from DER, 427' left of centerline, 790' MSL.

Pole beginning 1079' from DER, 554' left of centerline, up to 37' AGL/812' MSL.

Tree 1334' from DER, 332' right of centerline, 823' MSL.

Tree 1369' from DER, 384' left of centerline, 816' MSL.

Trees beginning 1383' from DER, 480' left of centerline, up to 820' MSL.

Tree 1413' from DER, 771' right of centerline, 824' MSL.

Trees beginning 1487' from DER, 264' right of centerline, up to 826' MSL.

CON'T

TAKEOFF MINIMUMS, (OBSTACLE) DEPARTURE PROCEDURES, AND DIVERSE VECTOR AREA (RADAR VECTORS)

24025

NC-1

TAKEOFF MINIMUMS, (OBSTACLE) DEPARTURE PROCEDURES, AND DIVERSE VECTOR AREA (RADAR VECTORS)

24025

RED WING, MN (CON'T)

RED WING RGNL (RGK) (CON'T)

Rwy 9 (CON'T), trees beginning 1911' from DER, 429' right of centerline, up to 835' MSL.

Trees beginning 1.2 NM from DER, 2172' left of centerline, up to 1032' MSL.

Tree 1.2 NM from DER, 2019' left of centerline, 1039' MSL.

Trees beginning 1.3 NM from DER, 1731' left of centerline, up to 1103' MSL.

Tree, vehicles, terrain beginning 1.3 NM from DER, 3' left of centerline, up to 1119' MSL.

Tree 1.6 NM from DER, 89' right of centerline, 1088' MSL.

Trees beginning 1.6 NM from DER, 36' right of centerline, up to 1097' MSL.

Trees beginning 1.6 NM from DER, 33' right of centerline, up to 1099' MSL.

Trees beginning 1.8 NM from DER, 9' left of centerline, up to 1120' MSL.

Trees beginning 1.8 NM from DER, 176' right of centerline, up to 1108' MSL.

Tree 1.9 NM from DER, 20' right of centerline, 1123' MSL.

Trees beginning 2 NM from DER, 13' left of centerline, up to 1127' MSL.

Trees beginning 2 NM from DER, 24' right of centerline, up to 1125' MSL.

Trees beginning 2 NM from DER, 12' right of centerline, up to 1130' MSL.

Tree 2.1 NM from DER, 1401' right of centerline, 1134' MSL.

Building, tree beginning 2.2 NM from DER, 307' right of centerline, up to 68' AGL/1139' MSL.

Trees beginning 2.2 NM from DER, 7' left of centerline, up to 1162' MSL.

Tree 2.2 NM from DER, 17' right of centerline, 1152' MSL.

Tree 2.5 NM from DER, 1342' right of centerline, 1192' MSL.

Rwy 27, vehicles beginning 12' from DER, 33' right of centerline, up to 807' MSL.

Trees beginning 379' from DER, 510' right of centerline, up to 800' MSL.

Tree 2290' from DER, 1034' left of centerline, 838' MSL.

REDWOOD FALLS, MN

REDWOOD FALLS MUNI (RWF)

TAKEOFF MINIMUMS AND (OBSTACLE) DEPARTURE PROCEDURES

ORIG 12MAR09 (09071) (FAA)

TAKEOFF MINIMUMS:

Rwys 5, 23, NA-Environmental.

TAKEOFF OBSTACLE NOTES:

Rwy 12, numerous buildings beginning 388' from DER, 376' right of centerline, up to 13' AGL/1052' MSL.

Numerous fences beginning 6' from DER, 329' right of centerline, up to 13' AGL/1052' MSL.

Tree 62' from DER, 444' left of centerline, 11' AGL/1040' MSL.

Rwy 30, multiple trees beginning 865' from DER, 401' right of centerline, up to 100' AGL/1119' MSL.

Vehicle on road 128' from DER, 306' right of centerline, 15' AGL/1027' MSL.

ROCHESTER, MN

ROCHESTER INTL (RST)

TAKEOFF MINIMUMS AND (OBSTACLE) DEPARTURE PROCEDURES

ORIG-A 20APR23 (23110) (FAA)

TAKEOFF OBSTACLE NOTES:

Rwy 3, tree 2781' from DER, 1123' left of centerline, 1352' MSL.

Rwy 13, trees beginning 1500' from DER, 846' right of centerline, up to 1364' MSL.

Tree 1561' from DER, 826' right of centerline, 1365' MSL.

Rwy 21, light poles 10' from DER, 54' left of centerline, 2' AGL/1316' MSL.

Rwy 31, light poles 10' from DER, 5' left of centerline, 2' AGL/1269' MSL.

Light poles 10' from DER, 5' right of centerline, 2' AGL/1269' MSL.

ROLLA, ND

ROLLA MUNI/LEONARD KRECH FLD (06D)

TAKEOFF MINIMUMS AND (OBSTACLE) DEPARTURE PROCEDURES

ORIG 13JAN11 (22139) (FAA)

TAKEOFF MINIMUMS:

Rwys 7, 25, NA-Environmental.

TAKEOFF OBSTACLE NOTES:

Rwy 14, vehicle on road 49' from DER, 23' left of centerline, 15' AGL/1830' MSL.

Trees beginning 1232' from DER, 209' left of centerline, up to 80' AGL/1867' MSL.

Rwy 32, trees beginning 2207' from DER, 59' left of centerline, up to 80' AGL/1929' MSL.

Trees beginning 651' from DER, 80' right of centerline, up to 80' AGL/1939' MSL.

22 FEB 2024 to 21 MAR 2024

22 FEB 2024 to 21 MAR 2024

TAKEOFF MINIMUMS, (OBSTACLE) DEPARTURE PROCEDURES, AND DIVERSE VECTOR AREA (RADAR VECTORS)

24025

TAKEOFF MINIMUMS, (OBSTACLE) DEPARTURE PROCEDURES, AND DIVERSE VECTOR AREA (RADAR VECTORS)

24025

ROSEAU, MN

ROSEAU MUNI/RUDY BILLBERG FLD (ROX)

TAKEOFF MINIMUMS AND (OBSTACLE) DEPARTURE PROCEDURES

ORIG-A 02DEC21 (21336) (FAA)

TAKEOFF MINIMUMS:

Rwys 6, 24, NA-Environmental.

TAKEOFF OBSTACLE NOTES:

Rwy 16, poles 138' from DER, 491' right of centerline, up to 35' AGL/1095' MSL.

Building 258' from DER, 504' right of centerline, 17' AGL/1078' MSL.

Tree 1582' from DER, 336' left of centerline, 1101' MSL.

Rwy 34, sign 20' from DER, 199' left of centerline, 2' AGL/1047' MSL.

Vehicles on roadway and vegetation beginning 131' from DER, 459' left of centerline, up to 12' AGL/1068' MSL.

ROSEBUD, SD

ROSEBUD SIOUX TRIBAL (SUO)

TAKEOFF MINIMUMS AND (OBSTACLE) DEPARTURE PROCEDURES

ORIG 07DEC17 (17341) (FAA)

TAKEOFF MINIMUMS:

Rwy 16, 300-1 ¼ or std. w/min. climb gradient of 240' per NM to 3500 or 1300-3 for VCOA.

DEPARTURE PROCEDURE:

Rwy 16, climb heading 177° to 3500 before turning left.

VCOA:

Rwy 16, obtain ATC approval for VCOA when requesting IFR clearance. Climb in visual conditions to cross Rosebud Sioux Tribal Airport at or above 3900 before proceeding on course.

TAKEOFF OBSTACLE NOTES:

Rwy 16, light 10' from DER, 18' right of centerline, 2' AGL/2725' MSL.

Light 10' from DER, 17' left of centerline, 2' AGL/2725' MSL.

Fence 867' from DER, 184' left of centerline, 10' AGL/ 2751' MSL.

Ground 1256' from DER, 679' left of centerline, 2795' MSL.

Secondary Rd 1526' from DER, 809' left of centerline, 2807' MSL.

Tree 1770' from DER, 882' left of centerline, 2818' MSL.

Rwy 34, light 10' from DER, 17' right of centerline, 2' AGL/2684' MSL.

Light 10' from DER, 18' left of centerline, 2' AGL/2685' MSL.

Ground 448' from DER, 213' right of centerline, 2695' MSL.

Ground 493' from DER, 40' right of centerline, 2697' MSL.

Ground 496' from DER, 108' right of centerline, 2697' MSL.

Ground 504' from DER, 8' left of centerline, 2698' MSL.

Bush 555' from DER, 166' right of centerline, 2698' MSL.

Ground 556' from DER, 107' left of centerline, 2698' MSL.

Fence 623' from DER, 110' left of centerline, 3' AGL/2698' MSL.

RUGBY, ND

RUGBY MUNI (RUG)

TAKEOFF MINIMUMS AND (OBSTACLE) DEPARTURE PROCEDURES

AMDT 1 24JUL14 (14205) (FAA)

TAKEOFF MINIMUMS:

Rwy 12, 300-1¼ or std. w/min. climb of 300' per NM to 2000.

TAKEOFF OBSTACLE NOTES:

Rwy 12, trees beginning 1186' from DER, 432' left of centerline, up to 67' AGL/1620' MSL.

Elevators beginning 1.4 NM from DER, 819' right of centerline, up to 246' AGL/1804' MSL.

Rwy 30, edge light 11' from DER, 9' right of centerline, 1' AGL/1534' MSL.

Edge light 11' from DER, 20' left of centerline, 1' AGL/1534' MSL.

RUSH CITY, MN

RUSH CITY RGNL (ROS)

TAKEOFF MINIMUMS AND (OBSTACLE) DEPARTURE PROCEDURES

ORIG 10FEB11 (11041) (FAA)

TAKEOFF OBSTACLE NOTES:

Rwy 16, multiple trees beginning 27' from DER, 315' left of centerline, up to 100' AGL/ 969' MSL.

Multiple trees beginning 838' from DER, 226' right of centerline, up to 100' AGL/ 997' MSL.

Pole 1712' from DER, 811' left of centerline, 50' AGL/ 970' MSL.

Rwy 34, trees 91' from DER, 472' left of centerline, 100' AGL/ 939' MSL.

Trees 1173' from DER, 375' right of centerline, 100' AGL/ 1029' MSL.

Trees 2250' from DER, 928' left of centerline, 100' AGL/ 1009' MSL.

22 FEB 2024 to 21 MAR 2024

22 FEB 2024 to 21 MAR 2024

TAKEOFF MINIMUMS, (OBSTACLE) DEPARTURE PROCEDURES, AND DIVERSE VECTOR AREA (RADAR VECTORS)

24025

NC-1

TAKEOFF MINIMUMS, (OBSTACLE) DEPARTURE PROCEDURES, AND DIVERSE VECTOR AREA (RADAR VECTORS)

24025

RUSHFORD, MN

RUSHFORD MUNI/ROBERT W BUNKE FLD (55Y)

TAKEOFF MINIMUMS AND (OBSTACLE) DEPARTURE PROCEDURES

AMDT 2A 01FEB18 (22251) (FAA)

DEPARTURE PROCEDURE:

Rwy 16, climb heading 161° to 1800 before turning left.

TAKEOFF OBSTACLE NOTES:

Rwy 16, trees beginning 132' from DER, 448' left of centerline, up to 100' AGL/1280' MSL.

Trees beginning 899' from DER, 685' right of centerline, up to 100' AGL/1319' MSL.

Rwy 34, trees beginning 308' from DER, 147' right of centerline, up to 100' AGL/1299' MSL.

Trees beginning 761' from DER, 34' left of centerline, up to 100' AGL/1319' MSL.

Trees beginning 1169' from DER, 23' right of centerline, up to 100' AGL/1344' MSL.

ST. CLOUD, MN

ST CLOUD RGNL (STC)

TAKEOFF MINIMUMS AND (OBSTACLE) DEPARTURE PROCEDURES

ORIG 27AUG09 (09239) (FAA)

TAKEOFF MINIMUMS:

Rwy 5, 300-1¼ or std. w/ min. climb of 201' per NM to 1300 or alternatively, with standard TAKEOFF minimums and a normal 200'/NM climb gradient, TAKEOFF must occur no later than 1100' prior to DER.

TAKEOFF OBSTACLE NOTES:

Rwy 5, tower 6201' from DER, 1416' left of centerline, 149' AGL/1179' MSL.

Multiple trees beginning 17' from DER, 373' right of centerline, up to 59' AGL/1081' MSL.

Multiple trees beginning 1752' from DER, 56' left of centerline, up to 80' AGL/1102' MSL.

Rwy 13, tree 1654' from DER, 884' right of centerline, 61' AGL/1078' MSL.

Tree 1265' from DER, 794' left of centerline, 42' AGL/1059' MSL.

Rwy 23, trees 2109' from DER, 29' right of centerline, up to 61' AGL/1082' MSL.

Trees 1725' from DER, 93' left of centerline, up to 55' AGL/1076' MSL.

Fence 74' from DER, 216' left of centerline, 2' AGL, 1023' MSL.

Rwy 31, terrain beginning 29' from DER, 50' right of centerline, up to 1083' MSL.

Terrain beginning 107' from DER, 7' left of centerline, up to 1060' MSL.

ST. JAMES, MN

ST JAMES MUNI (JYG)

TAKEOFF MINIMUMS AND (OBSTACLE) DEPARTURE PROCEDURES

ORIG-A 24MAY18 (18144) (FAA)

DEPARTURE PROCEDURE:

Rwy 15, climb to 1900 on heading 148° before turning eastbound.

TAKEOFF OBSTACLE NOTES:

Rwy 15, pole 8' from DER, 78' left of centerline, 4' AGL/1067' MSL.

Tree 58' from DER, 379' left of centerline, 1072' MSL.

Pole 1489' from DER, 611' left of centerline, 41' AGL/1112' MSL.

Tree, pole beginning 1510' from DER, 309' left of centerline, up to 1133' MSL.

Tree 2209' from DER, 79' right of centerline, 1124' MSL.

Trees beginning 2834' from DER, 25' left of centerline, up to 1139' MSL.

Tree 2849' from DER, 6' right of centerline, 1145' MSL.

Tree 2937' from DER, 5' left of centerline, 1142' MSL.

Rwy 33, pole 11' from DER, 78' left of centerline, 3' AGL/1063' MSL.

Pole 11' from DER, 78' right of centerline, 3' AGL/1063' MSL.

Tree 120' from DER, 326' left of centerline, 1066' MSL.

Trees beginning 2030' from DER, 911' left of centerline, up to 1134' MSL.

ST PAUL, MN

LAKE ELMO (21D)

TAKEOFF MINIMUMS AND (OBSTACLE) DEPARTURE PROCEDURES

AMDT 2 05OCT23 (23278) (FAA)

DEPARTURE PROCEDURE:

Rwy 4, climb on heading 038° to 1600 before turning right.

TAKEOFF OBSTACLE NOTES:

Rwy 4, tree 7' from DER, 484' right of centerline, 986' MSL.

Building 88' from DER, 521' left of centerline, 28' AGL/959' MSL.

Trees beginning 379' from DER, 489' right of centerline, up to 999' MSL.

Trees beginning 487' from DER, 165' right of centerline, up to 1007' MSL.

Trees beginning 1231' from DER, 793' left of centerline, up to 993' MSL.

Tree 1370' from DER, 699' left of centerline, 994' MSL.

Tree 1482' from DER, 622' left of centerline, 1006' MSL.

Trees beginning 1612' from DER, 549' left of centerline, up to 1008' MSL.

Tree 1629' from DER, 793' left of centerline, 1019' MSL.

Trees beginning 1727' from DER, 129' left of centerline, up to 1029' MSL.

Tree 2225' from DER, 797' right of centerline, 1020' MSL.

Trees beginning 2447' from DER, 29' right of centerline, up to 1022' MSL.

Tree 3630' from DER, 669' right of centerline, 1029' MSL.

CONT

TAKEOFF MINIMUMS, (OBSTACLE) DEPARTURE PROCEDURES, AND DIVERSE VECTOR AREA (RADAR VECTORS)

24025

TAKEOFF MINIMUMS, (OBSTACLE) DEPARTURE PROCEDURES, AND DIVERSE VECTOR AREA (RADAR VECTORS)

24025

ST. PAUL, MN (CON'T)

LAKE ELMO (21D) (CON'T)

Rwy 14, tree 41' from DER, 494' left of centerline, 983' MSL.
Vehicle on road 98' from DER, 497' right of centerline, 936' MSL.
Tree 1174' from DER, 796' right of centerline, 990' MSL.
Trees beginning 1299' from DER, 738' left of centerline, up to 1004' MSL.
Trees beginning 1435' from DER, 216' left of centerline, up to 1010' MSL.
Tree 2760' from DER, 37' left of centerline, 1011' MSL.
Tree 2987' from DER, 72' left of centerline, 1012' MSL.
Trees beginning 3055' from DER, 1081' right of centerline, up to 1020' MSL.
Trees beginning 3189' from DER, 1034' right of centerline, up to 1022' MSL.
Rwy 22, building beginning 100' from DER, 476' right of centerline, up to 22' AGL/947' MSL.
Pole 308' from DER, 492' right of centerline, 39' AGL/962' MSL.
Trees beginning 1517' from DER, 77' left of centerline, up to 983' MSL.
Trees beginning 1852' from DER, 134' left of centerline, up to 1001' MSL.
Tree 1911' from DER, 39' right of centerline, 973' MSL.
Tree 2357' from DER, 331' right of centerline, 986' MSL.
Rwy 32, terrain 11' from DER, 437' right of centerline, 926' MSL.
Building, tree beginning 572' from DER, 618' right of centerline, up to 23' AGL/950' MSL.
Tree 1007' from DER, 589' right of centerline, 975' MSL.
Tree 1081' from DER, 670' right of centerline, 978' MSL.
Pole 1414' from DER, 299' left of centerline, 47' AGL/965' MSL.
Pole beginning 1479' from DER, 66' left of centerline, up to 47' AGL/967' MSL.
Tree 2269' from DER, 181' right of centerline, 985' MSL.
Tree 4032' from DER, 1214' right of centerline, 1026' MSL.

ST PAUL DOWNTOWN HOLMAN FLD (STP)

TAKEOFF MINIMUMS AND (OBSTACLE) DEPARTURE PROCEDURES

AMDT 8A 17AUG17 (21112) (FAA)

TAKEOFF MINIMUMS:

Rwy 31, NA - Obstacles.
Rwy 9, std. w/min. climb of 340' per NM to 1300.
Rwy 13, std. w/min. climb of 235' per NM to 1500.
Rwy 27, 600-2 or std. w/min. climb of 442' per NM to 1500.
Rwy 32, std. w/min. climb of 340' per NM to 3000.

DEPARTURE PROCEDURE:

Rwy 9, climb heading 091° to 1400 before proceeding on course.
Rwy 13, climb heading 128° to 1300 before proceeding on course.
Rwy 14, climb heading 146° to 1400 before proceeding on course.
Rwy 27, climb heading 271° to 1700 before proceeding on course.
Rwy 32, climb heading 326° to 1400 before proceeding on course.

TAKEOFF OBSTACLE NOTES:

Rwy 9, mobile crane 1362' from DER, 124' left of centerline, 68' AGL/758' MSL.
Trees and silo 1464' from DER, 178' right of centerline, up to 116' AGL/816' MSL.
Trees and pole beginning 1.1 NM from DER, left and right of centerline, up to 100' AGL/1099' MSL.
Rwy 13, tree and tower beginning 1125' from DER, 609' left of centerline, up to 67' AGL/767' MSL.
Tree, pole, vent on building, stacks, and oil on stack beginning 1672' from DER, 55' right of centerline, up to 120' AGL/820' MSL.
Trees beginning 1.9 NM from DER, 2938' left of centerline, up to 100' AGL/1020' MSL.
Rwy 14, trees, OL on DME antenna, and pole beginning 290' from DER, 1' right of centerline, up to 129' AGL/819' MSL.
Trees and pole beginning 1099' from DER, 6' left of centerline, up to 87' AGL/777' MSL.
Rwy 27, trees, light pole, and flagpole beginning 617' from DER, 198' left of centerline, up to 119' AGL/829' MSL.
OL on antenna, buildings, tower, and tree beginning 810' from DER, 26' right of centerline, up to 165' AGL/955' MSL.
Trees and building beginning 3886' from DER, 120' left of centerline, up to 84' AGL/1014' MSL.
Tower 1.7 NM from DER, 633' left of centerline, 569' AGL/1279' MSL.
Rwy 32, vehicle on road, trees, railroad, poles, and NAVAID beginning 179' from DER, 267' right of centerline, up to 58' AGL/758' MSL.
Vehicle on road, railroad, and trees beginning 192' from DER, left and right of centerline, up to 59' AGL/759' MSL.
NAVAID 257' from DER, on centerline, 26' AGL/726' MSL.
Trees, poles, buildings, and tower beginning 3674' from DER, 616' right of centerline, up to 157' AGL/973' MSL.
Trees, buildings, tower, sign, and stack beginning 1924' from DER, 378' left of centerline, up to 143' AGL/969' MSL.

SAUK CENTRE, MN

SAUK CENTRE MUNI (D39)

TAKEOFF MINIMUMS AND (OBSTACLE) DEPARTURE PROCEDURES

ORIG 25AUG11 (11237) (FAA)

TAKEOFF MINIMUMS:

Rwys 8, 26, NA -Environmental.

TAKEOFF OBSTACLE NOTES:

Rwy 14, tree 1269' from DER, 39' right of centerline, 80' AGL/1319' MSL.
Rwy 32, tree 1105' from DER, 136' left of centerline, 80' AGL/1299' MSL.

TAKEOFF MINIMUMS, (OBSTACLE) DEPARTURE PROCEDURES, AND DIVERSE VECTOR AREA (RADAR VECTORS)

24025

NC-1

TAKEOFF MINIMUMS, (OBSTACLE) DEPARTURE PROCEDURES, AND DIVERSE VECTOR AREA (RADAR VECTORS)

24025

SIOUX FALLS, SD

JOE FOSS FLD (FSD)

TAKEOFF MINIMUMS AND (OBSTACLE) DEPARTURE PROCEDURES

AMDT 8A 07DEC17 (21112) (FAA)

TAKEOFF MINIMUMS:

Rwys 9, 27, NA - ATC request.**Rwy 33**, 200-1 $\frac{1}{2}$ or std. w/min. climb of 345' per NM to 1700.

DEPARTURE PROCEDURE:

Rwy 3, climb heading 30° to 2300 before turning eastbound.**Rwy 15**, climb heading 150° to 2000, then right turn direct FSD VORTAC, continue climb in FSD VORTAC holding pattern (hold NW, left turn, 147° inbound) to cross FSD VORTAC at or above MEA for route of flight.**Rwy 21**, climb heading 210° to 2200 before turning eastbound.**Rwy 33**, climb heading 330° to 2300 before turning eastbound.

TAKEOFF OBSTACLE NOTES:

Rwy 3, rwy light, poles beginning 5' from DER, 3' left of centerline, up to 2' AGL/1432' MSL.

Rwy light 5' from DER, 5' right of centerline, 2' AGL/1432' MSL.

Rwy 15, pole, rwy light beginning 11' from DER, 39' left of centerline, up to 2' AGL/1424' MSL.

Rwy light 11' from DER, 40' right of centerline, 2' AGL/1424' MSL.

Fence 112' from DER, 457' left of centerline, 10' AGL/1435' MSL.

Poles beginning 553' from DER, 419' left of centerline, up to 22' AGL/1444' MSL.

Pole 919' from DER, 351' left of centerline, 26' AGL/1448' MSL.

Tank, tree beginning 1282' from DER, 222' left of centerline, up to 47' AGL/1472' MSL.

Poles beginning 1330' from DER, 708' right of centerline, up to 39' AGL/1460' MSL.

Pole 1609' from DER, 530' right of centerline, 44' AGL/1463' MSL.

T-L twr 1627' from DER, 806' left of centerline, 53' AGL/1474' MSL.

Poles beginning 1701' from DER, 180' right of centerline, up to 48' AGL/1468' MSL.

T-L twr, pole, tree beginning 1725' from DER, 210' left of centerline, up to 58' AGL/1480' MSL.

T-L twr 2592' from DER, 893' right of centerline, 68' AGL/1489' MSL.

Pole 2857' from DER, 314' right of centerline, 73' AGL/1495' MSL.

Building, tower, T-L twr, tree beginning 3053' from DER, 228' left of centerline, up to 106' AGL/1573' MSL.

Tree 3297' from DER, 413' right of centerline, 1514' MSL.

Tree 3344' from DER, 441' right of centerline, 1520' MSL.

Rwy 21, rwy light 4' from DER, 4' right of centerline, 2' AGL/1426' MSL.

Rwy light, sign beginning 4' from DER, 5' left of centerline, up to 2' AGL/1426' MSL.

Tree 424' from DER, 607' right of centerline, 1457' MSL.

Trees beginning 567' from DER, 543' right of centerline, up to 1458' MSL.

Trees beginning 986' from DER, 531' right of centerline, up to 1479' MSL.

Rwy 33, NAVAIDs beginning 34' from DER, 113' right of centerline, up to 4' AGL/1431' MSL.

Tree, tank beginning 1211' from DER, 746' left of centerline, up to 1511' MSL.

Trees beginning 2403' from DER, 654' left of centerline, up to 1519' MSL.

Trees beginning 2483' from DER, 844' left of centerline, up to 1536' MSL.

Tree, pole beginning 2707' from DER, 263' left of centerline, up to 1537' MSL.

Poles beginning 3491' from DER, 366' right of centerline, up to 44' AGL/1518' MSL.

Tree, pole beginning 3546' from DER, 148' left of centerline, up to 1545' MSL.

NAVAID, pole beginning 3559' from DER, 147' left of centerline, up to 58' AGL/1577' MSL.

Pole 3594' from DER, 138' right of centerline, 40' AGL/1521' MSL.

Pole 3596' from DER, 139' right of centerline, 40' AGL/1522' MSL.

Tower, pole, NAVAIID, tree beginning 3638' from DER, 79' left of centerline, up to 65' AGL/1586' MSL.

Tree 3677' from DER, 108' right of centerline, 1525' MSL.

Tree 3784' from DER, 362' right of centerline, 1537' MSL.

Trees beginning 4205' from DER, 5' right of centerline, up to 1545' MSL.

Tree 5300' from DER, 769' left of centerline, 1587' MSL.

tree 5319' from DER, 1650' left of centerline, 1593' MSL.

Tree 5345' from DER, 888' left of centerline, 1601' MSL.

Tree, pole beginning 5392' from DER, 1026' left of centerline, up to 1607' MSL.

Trees beginning 6034' from DER, 1681' left of centerline, up to 1613' MSL.

SISSETON, SD

SISSETON MUNI (8D3)

TAKEOFF MINIMUMS AND (OBSTACLE) DEPARTURE PROCEDURES

ORIG 21JUL16 (16203) (FAA)

TAKEOFF MINIMUMS:

Rwys 4, 22, NA-Environmental.

DEPARTURE PROCEDURE:

Rwy 34, climb heading 344° to 1600 before turning left.

TAKEOFF OBSTACLE NOTES:

Rwy 16, poles beginning 1462' from DER, 709' left of centerline, 1216' MSL.

Fence beginning 51' from DER, crossing left to right, 5' AGL/1166' MSL.

Trees beginning 934' from DER, 710' right of centerline, 1235' MSL.

Pole 1508' from DER, 878' right of centerline, 41' AGL/1201' MSL.

Pole 1562' from DER, 638' right of centerline, 45' AGL/1205' MSL.

Rwy 34, trees beginning 832' from DER, 618' left of centerline, 1194' MSL.

TAKEOFF MINIMUMS, (OBSTACLE) DEPARTURE PROCEDURES, AND DIVERSE VECTOR AREA (RADAR VECTORS)

24025

TAKEOFF MINIMUMS, (OBSTACLE) DEPARTURE PROCEDURES, AND DIVERSE VECTOR AREA (RADAR VECTORS)

24025

SLAYTON, MN

SLAYTON MUNI (DVP)

TAKEOFF MINIMUMS AND (OBSTACLE) DEPARTURE PROCEDURES

ORIG 22SEP11 (11265) (FAA)

TAKEOFF OBSTACLE NOTES:

Rwy 17, trees beginning 951' from DER, 345' right of centerline, up to 100' AGL/1723' MSL.

Power lines beginning 1531' from DER, left and right of centerline, 40' AGL/1663' MSL.

Vehicle on road beginning at DER, 234' right of centerline, 15' AGL/1638' MSL.

Terrain beginning 65' from DER, left and right of centerline up to 1657' MSL.

Rwy 35, trees beginning 1034' from DER, left and right of centerline, up to 100' AGL/1715' MSL.

Power lines beginning 892' from DER, 206' left of centerline, 40' AGL/1655' MSL.

Vehicle on roads beginning at DER, 230' left and right of centerline, 15' AGL/1630' MSL.

Terrain beginning 271' from DER, left and right of centerline up to 1650' MSL.

SOUTH ST PAUL, MN

SOUTH ST PAUL MUNI/RICHARD E FLEMING FLD (SGS)

TAKEOFF MINIMUMS AND (OBSTACLE) DEPARTURE PROCEDURES

AMDT 1 13NOV14 (22307) (FAA)

TAKEOFF MINIMUMS:

Rwy 16, 300-1% or std. w/min. climb of 225' per NM to 1200 or alternatively, with std. takeoff minimums and a normal 200' per NM climb gradient, takeoff must occur no later than 1900' prior to DER.**Rwy 34**, 200-1% or std. w/min. climb of 220' per NM to 1100 or alternatively, with std. takeoff minimums and a normal 200' per NM climb gradient, takeoff must occur no later than 1500' prior to DER.

TAKEOFF OBSTACLE NOTES:

Rwy 16, tree, 1' from DER, 321' left of centerline, 56' AGL/877' MSL.

Trees beginning 108' from DER, 103' left of centerline, up to 68' AGL/889' MSL.

Trees beginning 1021' from DER, 88' left of centerline, up to 85' AGL/898' MSL.

Trees beginning 116' from DER, 193' right of centerline, up to 75' AGL/894' MSL.

Trees beginning 1108' from DER, 78' right of centerline up to 64' AGL/875' MSL.

Trees beginning 2123' from DER, 444' right of centerline, up to 100' AGL/1069' MSL.

Rwy 34, poles, trees and buildings beginning 76' from DER, 274' left of centerline, up to 79' AGL/880' MSL.

Poles and trees beginning 1021' from DER, 6' left of centerline, up to 82' AGL/901' MSL.

Trees beginning 2048' from DER, 71' left of centerline, up to 68' AGL/889' MSL.

Tower 1 mile from DER, 657' left of centerline, 103' AGL/987' MSL.

Trees and buildings beginning 84' from DER, 351' right of centerline, up to 38' AGL/856' MSL.

Trees beginning 1042' from DER, 54' right of centerline, up to 72' AGL/892' MSL.

Trees beginning 2017' from DER, 10' right of centerline, up to 80' AGL/899' MSL.

SPEARFISH, SD

BLACK HILLS/CLYDE ICE FLD (SPF)

TAKEOFF MINIMUMS AND (OBSTACLE) DEPARTURE PROCEDURES

AMDT 2 08NOV18 (21336) (FAA)

DEPARTURE PROCEDURE:

Use SWUNG (RNAV) DEPARTURE.

TAKEOFF OBSTACLE NOTES:

Rwy 13, lighting 9' from DER, 17' right of centerline, 2' AGL/3897' MSL.

Lighting beginning 9' from DER, 17' left of centerline, up to 2' AGL/3897' MSL.

Terrain beginning 185' from DER, 320' right of centerline, up to 3904' MSL.

Terrain 338' from DER, 496' right of centerline, 3905' MSL.

Lighting 487' from DER, 579' right of centerline, 1' AGL/3909' MSL.

Terrain 562' from DER, 628' right of centerline, 3911' MSL.

Vehicle on traverse way 1071' from DER, 480' right of centerline, 3931' MSL.

Rwy 31, lighting 9' from DER, 18' left of centerline, 2' AGL/3886' MSL.

Lighting 9' from DER, 17' right of centerline, 2' AGL/3886' MSL.

Terrain beginning 53' from DER, 356' left of centerline, up to 3918' MSL.

Terrain 142' from DER, 394' right of centerline, 3897' MSL.

Terrain 192' from DER, 492' right of centerline, 3902' MSL.

Terrain beginning 328' from DER, 395' right of centerline, up to 3907' MSL.

Terrain beginning 346' from DER, 450' left of centerline, up to 3929' MSL.

Terrain 592' from DER, 641' left of centerline, 3942' MSL.

Pole, terrain beginning 734' from DER, 446' left of centerline, up to 9' AGL/3986' MSL.

Tree 1.1 NM from DER, 2402' right of centerline, 4084' MSL.

Trees, vehicle on traverse way beginning 1.2 NM from DER, 1993' right of centerline, up to 4112' MSL.

Trees, terrain, vehicle on traverse way beginning 1.2 NM from DER, 1883' right of centerline, up to 4126' MSL.

Terrain, trees beginning 1.2 NM from DER, 1788' right of centerline, up to 4155' MSL.

Vehicle on traverse way 1.3 NM from DER, 2624' right of centerline, 4217' MSL.

Trees, terrain beginning 1.3 NM from DER, 744' right of centerline, up to 4228' MSL.

22 FEB 2024 to 21 MAR 2024

22 FEB 2024 to 21 MAR 2024

TAKEOFF MINIMUMS, (OBSTACLE) DEPARTURE PROCEDURES, AND DIVERSE VECTOR AREA (RADAR VECTORS)

24025

TAKEOFF MINIMUMS, (OBSTACLE) DEPARTURE PROCEDURES, AND DIVERSE VECTOR AREA (RADAR VECTORS)

24025

SPRINGFIELD, MN

SPRINGFIELD MUNI (D42)

TAKEOFF MINIMUMS AND (OBSTACLE) DEPARTURE PROCEDURES

ORIG 10JAN13 (13010) (FAA)

TAKEOFF OBSTACLE NOTES:

Rwy 13, trees beginning 267' from DER, 267' right of centerline, up to 100' AGL/1149' MSL.

Building 802' from DER, 684' left of centerline, up to 30' AGL/1089' MSL.

Trees beginning 763' from DER, 603' left of centerline, up to 100' AGL/1159' MSL.

Trees beginning 1083' from DER, 240' right of centerline, up to 100' AGL/1169' MSL.

Trees beginning 3562' from DER, 98' left of centerline, up to 100' AGL/1169' MSL.

Rwy 31, trees beginning 2248' from DER, 183' left of centerline, up to 100' AGL/1189' MSL.

Building 604' from DER, 563' right of centerline, up to 30' AGL/1109' MSL.

Trees beginning 656' from DER, 481' right of centerline, up to 100' AGL/1169' MSL.

Trees beginning 3889' from DER, 1495' right of centerline, up to 100' AGL/1199' MSL.

STANLEY, ND

STANLEY MUNI (08D)

TAKEOFF MINIMUMS AND (OBSTACLE) DEPARTURE PROCEDURES

ORIG-A 29DEC22 (22363) (FAA)

TAKEOFF OBSTACLE NOTES:

Rwy 10, vehicles on roadway, vegetation beginning 2' from DER, 290' right of centerline, up to 2257' MSL.

Pole 162' from DER, 488' left of centerline, 31' AGL/2269' MSL.

Tree 351' from DER, 512' right of centerline, 57' AGL/2288' MSL.

Rwy 28, vegetation, light poles beginning 4' from DER, 68' right of centerline, up to 2253' MSL.

Vegetation 115' from DER, 484' right of centerline, 2255' MSL.

STAPLES, MN

STAPLES MUNI (SAZ)

TAKEOFF MINIMUMS AND (OBSTACLE) DEPARTURE PROCEDURES

AMDT 3 31MAY12 (12152) (FAA)

TAKEOFF MINIMUMS:

Rwy 14, 400-2 or std. w/min. climb of 285' per NM to 1800.

TAKEOFF OBSTACLE NOTES:

Rwy 14, towers beginning 1.60 NM from DER, 1868' right of centerline, up to 367' AGL/1634' MSL.

Vehicles on road and trees beginning 38' from DER, 76' right of centerline, up to 63' AGL/1332' MSL.

Vehicles on road, trees and pole beginning 38' from DER, 77' left of centerline, up to 63' AGL/1342' MSL.

Rwy 32, vehicles on road and trees beginning 228' from DER, 8' right of centerline, up to 85' AGL/1374' MSL.

Vehicles on road and trees beginning 2' from DER, 18' left of centerline, up to 79' AGL/1368' MSL.

STURGIS, SD

STURGIS MUNI (49B)

TAKEOFF MINIMUMS AND (OBSTACLE) DEPARTURE PROCEDURES

AMDT 1A 15OCT15 (15288) (FAA)

TAKEOFF MINIMUMS:

Rwys 5, 23, NA-Environmental.

DEPARTURE PROCEDURE:

Rwy 11, climb heading 096° to 5200, then climbing right turn to 7000 direct RAP VORTAC.

Rwy 29, climb heading 291° to 5000, then climbing right turn to 7000 direct RAP VORTAC.

TAKEOFF OBSTACLE NOTES:

Rwy 11, fence 37' from DER, 347' left of centerline, 6' AGL/3210' MSL.

Rwy 29, trees 63' from DER, 271' right of centerline, up to 20' AGL/3265' MSL.

Ground 134' from DER, 443' left of centerline, 3248' MSL.

THIEF RIVER FALLS, MN

THIEF RIVER FALLS RGNL (TVF)

TAKEOFF MINIMUMS AND (OBSTACLE) DEPARTURE PROCEDURES

ORIG-A 13NOV14 (14317) (FAA)

TAKEOFF OBSTACLE NOTES:

Rwy 4, light 41' from DER, 77' left of centerline, 2' AGL/1120' MSL.

Terrain 2' from DER, 255' right of centerline, 1119' MSL.

Light 41' from DER, 75' right of centerline, 2' AGL/1120' MSL.

Road with vehicle beginning 578' from DER, 595' right of centerline, up to 15' AGL/1135' MSL.

Rwy 13, lights beginning 6' from DER, 4' left of centerline, up to 2' AGL/1114' MSL.

Sign 22' from DER, 253' left of centerline, 3' AGL/1114' MSL.

Lights beginning 6' from DER, 5' right of centerline, up to 2' AGL/1114' MSL.

Rwy 22, utilities and lights beginning 10' from DER, 77' left of centerline, up to 4' AGL/1115' MSL.

Sign 38' from DER, 197' left of centerline, 4' AGL/1115' MSL.

Light 40' from DER, 77' right of centerline, 3' AGL/1114' MSL.

Trees beginning 545' from DER, 183' right of centerline, up to 91' AGL/1181' MSL.

Rwy 31, lights beginning 9' from DER, 39' left of centerline, up to 3' AGL/1116' MSL.

Trees beginning 275' from DER, 549' left of centerline, up to 61' AGL/1172' MSL.

Lights beginning 9' from DER, 40' right of centerline, up to 2' AGL/1116' MSL.

TAKEOFF MINIMUMS, (OBSTACLE) DEPARTURE PROCEDURES, AND DIVERSE VECTOR AREA (RADAR VECTORS)

24025

NC-1

TAKEOFF MINIMUMS, (OBSTACLE) DEPARTURE PROCEDURES, AND DIVERSE VECTOR AREA (RADAR VECTORS)

24025

TIOGA, ND

TIOGA MUNI (D60)

TAKEOFF MINIMUMS AND (OBSTACLE) DEPARTURE PROCEDURES

AMDT 1 13SEP18 (18256) (FAA)

TAKEOFF MINIMUMS:

Rwys 3, 21, NA-Environmental.

Rwy 30, 300 - 1 ½ or std. w/min. climb of 249' per NM to 2500, or alternately, with std. takeoff minimums and a normal 200' per mile climb gradient, takeoff must occur no later than 2200' prior to DER.

TAKEOFF OBSTACLE NOTES:

Rwy 12, lighting 10' from DER, 18' right of centerline, 2' AGL/2272' MSL.

Lighting 10' from DER, 15' left of centerline, 2' AGL/2273' MSL.

Pole, traverse way beginning 630' from DER, 144' right of centerline, up to 23' AGL/2311' MSL.

Rwy 30, lighting 9' from DER, 18' right of centerline, 2' AGL/2242' MSL.

Lighting 9' from DER, 18' left of centerline, 2' AGL/2242' MSL.

Building 554' from DER, 640' right of centerline, 27' AGL/2264' MSL.

General utility 4410' from DER, 1465' right of centerline, 170' AGL/2366' MSL.

Stack 5674' from DER, 1751' right of centerline, 167' AGL/2417' MSL.

TOWER, MN

TOWER MUNI (12D)

TAKEOFF MINIMUMS AND (OBSTACLE) DEPARTURE PROCEDURES

ORIG 07MAY09 (09127) (FAA)

TAKEOFF MINIMUMS:

Rwy 8, NA-Obstacles.

TAKEOFF OBSTACLE NOTES:

Rwy 26, tree 2315' from DER, 700' right of centerline, 100' AGL/1479' MSL.

TRACY, MN

TRACY MUNI (TKC)

TAKEOFF MINIMUMS AND (OBSTACLE) DEPARTURE PROCEDURES

ORIG-A 31DEC20 (20366) (FAA)

TAKEOFF MINIMUMS:

Rwys 17, 35, NA-Environmental.

Rwy 29, 300-2¾ or std. w/min. climb of 250' per NM to 1800.

TAKEOFF OBSTACLE NOTES:

Rwy 11, tree 56' from DER, 174' right of centerline, 20' AGL/1342' MSL.

Numerous trees and bushes beginning 137' from DER, 86' left of centerline, up to 100' AGL/1410' MSL.

Rwy 29, tower 1.9 NM from DER, 1951' left of centerline, 265' AGL/1625' MSL.

TWO HARBORS, MN

RICHARD B. HELGESON (TWM)

TAKEOFF MINIMUMS AND (OBSTACLE) DEPARTURE PROCEDURES

ORIG 30JUN11 (11181) (FAA)

TAKEOFF MINIMUMS:

Rwys 15, 33, NA-Environmental.

TAKEOFF OBSTACLE NOTES:

Rwy 6, multiple trees, beginning 20' from DER, 44' right of centerline, up to 40' AGL/1122' MSL.

Multiple trees, beginning 46' from DER, 201' left of centerline, up to 40' AGL/1126' MSL.

Rwy 24, multiple trees, beginning 13' from DER, 61' right of centerline, up to 40' AGL/1156' MSL.

Multiple trees, beginning 56' from DER, 97' left of centerline, up to 40' AGL/1138' MSL.

VALLEY CITY, ND

BARNES COUNTY MUNI (BAC)

TAKEOFF MINIMUMS AND (OBSTACLE) DEPARTURE PROCEDURES

ORIG-A 10SEP20 (20254) (FAA)

TAKEOFF MINIMUMS:

Rwys 5, 8, 17, 23, 26, 35, NA-Environmental.

TAKEOFF OBSTACLE NOTES:

Rwy 13, vehicle on road, 111' from DER, 356' right of centerline, 15' AGL/1396' MSL.

Trees beginning 644' from DER, 242' right of centerline, up to 40' AGL/1421' MSL.

Rwy 31, terrain beginning 32' from DER, 20' right of centerline, up to 1424' MSL.

Vehicle on road 38' from DER, 285' right of centerline, 15' AGL/1418' MSL.

Fence 71' from DER, 292' left of centerline, 4' AGL/1407' MSL.

Terrain beginning 120' from DER, 125' left of centerline, up to 1447' MSL.

Fence 198' from DER, 299' right of centerline, 4' AGL/1408' MSL.

Trees beginning 365' from DER, 10' left of centerline, up to 40' AGL/1457' MSL.

Tree 545' from DER, 607' right of centerline, 16' AGL/1436' MSL.

TAKEOFF MINIMUMS, (OBSTACLE) DEPARTURE PROCEDURES, AND DIVERSE VECTOR AREA (RADAR VECTORS)

24025

NC-1

TAKEOFF MINIMUMS, (OBSTACLE) DEPARTURE PROCEDURES, AND DIVERSE VECTOR AREA (RADAR VECTORS)

24025

VERMILLION, SD

HAROLD DAVIDSON FLD (VMR)

TAKEOFF MINIMUMS AND (OBSTACLE) DEPARTURE PROCEDURES

AMDT 1 27AUG09 (22083) (FAA)

TAKEOFF OBSTACLE NOTES:

Rwy 12, road 1' from DER, 200' right of centerline, up to 15' AGL/1156' MSL.

Multiple trees beginning 541' from DER, 366' right of centerline, up to 62' AGL/1202' MSL.

Rwy 30, road 79' from DER 342' left of centerline 15' AGL/1155' MSL.

Road 200' from DER, 450' right of centerline, 15' AGL/1160' MSL.

Fence 199' from DER, 347' left of centerline, 6' AGL/1150' MSL.

WADENA, MN

WADENA MUNI (ADC)

TAKEOFF MINIMUMS AND (OBSTACLE) DEPARTURE PROCEDURES

AMDT 1 22AUG13 (13234) (FAA)

TAKEOFF OBSTACLE NOTES:

Rwy 34, runway lights beginning 38' from DER, 76' left and right of centerline 5' AGL/1369' MSL.

Rising terrain and trees beginning 69' from DER, 267' left of centerline, up to 20' AGL/1381' MSL.

Trees beginning 1678' from DER, 213' right of centerline, up to 91' AGL/1436' MSL.

Trees beginning 2445' from DER, 272' right of centerline, up to 96' AGL/1447' MSL.

WAGNER, SD

WAGNER MUNI (AGZ)

TAKEOFF MINIMUMS AND (OBSTACLE) DEPARTURE PROCEDURES

ORIG 17OCT13 (13290) (FAA)

TAKEOFF MINIMUMS:

Rwys 14, 32, NA-Environmental.

TAKEOFF OBSTACLE NOTES:

Rwy 9, vehicles on roadway beginning 629' from DER, 162' right of centerline, up to 15' AGL/1485' MSL.

Trees beginning 700' from DER, 227' right of centerline, up to 49' AGL/1514' MSL.

Trees beginning 727' from DER, 532' left of centerline, up to 44' AGL/1508' MSL.

Building and pole beginning 781' from DER, 416' left of centerline, up to 26' AGL/1491' MSL.

Trees beginning 881' from DER, 229' right of centerline, up to 40' AGL/1505' MSL.

Tree 1239' from DER, 558' left of centerline, 36' AGL/1501' MSL.

Rwy 27, terrain 13' from DER, 371' right of centerline, 1478 MSL.

Vehicles on roadway beginning 338' from DER, 556' right of centerline, up to 15' AGL/1494' MSL.

Tree 939' from DER, 462' left of centerline, 32' AGL/1509' MSL.

Trees beginning 1331' from DER, 409' right of centerline, up to 53' AGL/1530' MSL.

WAHPETON, ND

HARRY STERN (BWP)

TAKEOFF MINIMUMS AND (OBSTACLE) DEPARTURE PROCEDURES

AMDT 1 30JUN11 (11181) (FAA)

TAKEOFF MINIMUMS:

Rwys 3, 21, NA-Environmental.

TAKEOFF OBSTACLE NOTES:

Rwy 15, trees beginning 1020' from DER, 114' left of centerline, up to 74' AGL/ 1033' MSL.

Trees beginning 2753' from DER, 457' right of centerline, up to 86' AGL/1045' MSL.

Rwy 33, electrical system 657' from DER, 632' right of centerline, 71' AGL/1010' MSL.

Trees beginning 714' from DER, 33' right of centerline, up to 70' AGL/ 1039' MSL.

Electrical system 1570' from DER, 258' right of centerline, 68' AGL/1032' MSL.

Trees beginning 1326' from DER, 15' left of centerline, up to 75' AGL/1039' MSL.

WALHALLA, ND

WALHALLA MUNI (96D)

TAKEOFF MINIMUMS AND (OBSTACLE) DEPARTURE PROCEDURES

ORIG 05MAY11 (11125) (FAA)

TAKEOFF MINIMUMS:

Rwy 15, 400-2% or std. w/min. climb gradient of 260' per NM to 1500.

DEPARTURE PROCEDURE:

Rwy 15, Climb heading 164° to 1500 before turning right.

TAKEOFF OBSTACLE NOTES:

Rwy 15, vehicles on roadway beginning 478' from DER, 583' right of centerline, 15' AGL/969' MSL.

Trees beginning 734' from DER, 623' right to 708' left of centerline, up to 100' AGL/1054' MSL.

Rwy 33, trees beginning 53' from DER, 12' left to 654' right of centerline, up to 100' AGL/1 049' MSL.

Power lines beginning 81' from DER, 266' left of centerline, up to 70' AGL/1019' MSL.

Vehicles on roadway beginning 113' from DER, 490' left of centerline, 15' AGL/964' MSL.

TAKEOFF MINIMUMS, (OBSTACLE) DEPARTURE PROCEDURES, AND DIVERSE VECTOR AREA (RADAR VECTORS)

24025

TAKEOFF MINIMUMS, (OBSTACLE) DEPARTURE PROCEDURES, AND DIVERSE VECTOR AREA (RADAR VECTORS)

24025

WALKER, MN

WALKER MUNI (Y49)

TAKEOFF MINIMUMS AND (OBSTACLE) DEPARTURE PROCEDURES

ORIG 03APR14 (14093) (FAA)

TAKEOFF MINIMUMS:

Rwy 33, 300-1¼ or std. w/min. climb of 235' per NM to 1600, or alternatively, with std. takeoff minimums and a normal 200' per NM climb gradient, takeoff must occur no later than 1800' prior to DER.

TAKEOFF OBSTACLE NOTES:

Rwy 15, terrain beginning 1' from DER, 1' right of centerline crossing left of centerline, 1408' MSL.

Lights 38' from DER, 76' left and right of centerline, 2' AGL/1348' MSL.

Trees beginning 220' from DER, 466' right of centerline, up to 50' AGL/1396' MSL.

Trees beginning 330' from DER, 408' left of centerline, up to 38' AGL/1384' MSL.

Trees beginning 453' from DER, 400' left and right crossing centerline, up to 48' AGL/1453' MSL.

Rwy 33, lights 38' from DER, 77' left and right of centerline, 3' AGL/1348' MSL.

Terrain beginning 84' from DER, 37' left and right of centerline, 1418' MSL.

Vehicle on road 250' from DER, 455' right of centerline, 15' AGL/1360' MSL.

Tree 328' from DER, 200' right of centerline, 6' AGL/1354' MSL.

Trees beginning 420' from DER, 370' left of centerline, up to 55' AGL/1388' MSL.

Trees beginning 903' from DER, 19' right and left of centerline, up to 39' AGL/1392' MSL.

Trees beginning 2213' from DER, 100' left and right crossing centerline, up to 72' AGL/1404' MSL.

Terrain beginning 2916' from DER, 20' left and right of centerline, 1503' MSL.

Trees beginning 3597' from DER, 400' left and right crossing centerline, up to 128' AGL/1509' MSL.

WARREN, MN

WARREN MUNI (D37)

TAKEOFF MINIMUMS AND (OBSTACLE) DEPARTURE PROCEDURES

ORIG-A 08JAN15 (15008) (FAA)

TAKEOFF MINIMUMS:

Rwys 4, 22, NA-Environmental.

DEPARTURE PROCEDURE:

Rwy 30, climb runway heading to 1400 before turning on course.

TAKEOFF OBSTACLE NOTES:

Rwy 12, trees beginning 379' from DER, 306' left of centerline, up to 86' AGL/973' MSL.

Light support structure 3' from DER, 17' right of centerline, 2' AGL/888' MSL.

Trees beginning 926' from DER, left and right of centerline, up to 71' AGL/955' MSL.

Rwy 30, trees beginning 30' from DER, 86' right of centerline, up to 15' AGL/904' MSL.

Trees, poles and antenna beginning 331' from DER, 373' right of centerline, up to 62' AGL/948' MSL.

Trees and bush beginning 51' from DER, 36' left of centerline, up to 68' AGL/954' MSL.

Vehicles on road beginning 233' from DER, 179' right of centerline, up to 15' AGL/906' MSL.

WARROAD, MN

WARROAD INTL MEML (RRT)

TAKEOFF MINIMUMS AND (OBSTACLE) DEPARTURE PROCEDURES

ORIG-A 23JUN16 (21112) (FAA)

TAKEOFF MINIMUMS:

Rwys 4, 22, NA-Environmental.

TAKEOFF OBSTACLE NOTES:

Rwy 13, pole 148' from DER, 471' right of centerline, 24' AGL/1093' MSL.

WASECA, MN

WASECA MUNI/MAYNARD RICHARD STENSRUD FLD (ACQ)

TAKEOFF MINIMUMS AND (OBSTACLE) DEPARTURE PROCEDURES

ORIG 15JAN09 (22307) (FAA)

TAKEOFF OBSTACLE NOTES:

Rwy 15, tree 560' from DER, 560' right of centerline, 100' AGL/1239' MSL.

Terrain beginning 172' from DER, on centerline, up to 1149' MSL.

Rwy 33, tree 5042' from DER, 1533' right of centerline, 100' AGL/1259' MSL.

WATERTOWN, SD

WATERTOWN RGNL (ATY)

TAKEOFF MINIMUMS AND (OBSTACLE) DEPARTURE PROCEDURES

ORIG-A 26MAY16 (16147) (FAA)

TAKEOFF OBSTACLE NOTES:

Rwy 30, light 10' from DER, 30' left of centerline, 1' AGL/1749' MSL.

Light 11' from DER, 30' right of centerline, 1' AGL/1749' MSL.

Tree, 2091' from DER, 34' right of centerline, 100' AGL/1806' MSL.

Tree 2241' from DER, 812' left of centerline, 100' AGL/1805' MSL.

Rwy 35, sign, 102' from DER, 4' left of centerline, 10' AGL/1750' MSL.

TAKEOFF MINIMUMS, (OBSTACLE) DEPARTURE PROCEDURES, AND DIVERSE VECTOR AREA (RADAR VECTORS)

24025

TAKEOFF MINIMUMS, (OBSTACLE) DEPARTURE PROCEDURES, AND DIVERSE VECTOR AREA (RADAR VECTORS)

24025

WATFORD CITY, ND

WATFORD CITY MUNI (S25)

TAKEOFF MINIMUMS AND (OBSTACLE) DEPARTURE PROCEDURES

AMDT 2 07OCT21 (21280) (FAA)

TAKEOFF MINIMUMS:

Rwy 30, 300-1% or std. w/min. climb of 330' per NM to 2500.

DEPARTURE PROCEDURE:

Rwy 30, climb on heading 296° to 2600 before turning left.

TAKEOFF OBSTACLE NOTES:

Rwy 12, terrain beginning 2' from DER, 116' right of centerline, up to 2147' MSL.

Terrain beginning 9' from DER, 106' left of centerline, up to 2144' MSL.

Terrain 15' from DER, 444' left of centerline, 2176' MSL.

Terrain beginning 115' from DER, 184' left of centerline, up to 2187' MSL.

Terrain 518' from DER, 546' right of centerline, 2148' MSL.

Vehicles on road and terrain beginning 686' from DER, 482' right of centerline, up to 2170' MSL.

Terrain beginning 1395' from DER, 759' right of centerline, up to 2180' MSL.

Terrain 1507' from DER, 865' right of centerline, 2182' MSL.

Terrain 1656' from DER, 871' right of centerline, 2186' MSL.

Fence and terrain beginning 1730' from DER, 845' right of centerline, up to 5' AGL/2197' MSL.

Rwy 30, fence 190' from DER, 17' left of centerline, 11' AGL/2069' MSL.

Pole 191' from DER, 442' left of centerline, 15' AGL/2078' MSL.

Fence 206' from DER, 6' right of centerline, 11' AGL/2070' MSL.

Poles, vehicles on road and tree beginning 238' from DER, 48' left of centerline, up to 16' AGL/2080' MSL.

Tree 326' from DER, 1' right of centerline, 2077' MSL.

Vehicles on road and poles beginning 437' from DER, 31' right of centerline, up to 2078' MSL.

Rwy 30 (CON'T), trees beginning 438' from DER, 406' left of centerline, up to 2121' MSL.

Trees, antenna, poles, buildings and sign beginning 631' from DER, 2' right of centerline, up to 2122' MSL.

Trees, building, terrain and pole beginning 685' from DER, 9' left of centerline, up to 2123' MSL.

Trees beginning 1336' from DER, 213' right of centerline, up to 2124' MSL.

Tree 3166' from DER, 68' right of centerline, 2148' MSL.

Trees 1 NM from DER, 2112' left of centerline, up to 2245' MSL.

Trees beginning 1.1 NM from DER, 1323' left of centerline, up to 2252' MSL.

Pole, towers and tree beginning 1.2 NM from DER, 1802' left of centerline, up to 139' AGL/2379' MSL.

Tank 1.3 NM from DER, 1997' left of centerline, 132' AGL/2356' MSL.

WESSINGTON SPRINGS, SD

WESSINGTON SPRINGS (4X4)

TAKEOFF MINIMUMS AND (OBSTACLE) DEPARTURE PROCEDURES

ORIG 07DEC17 (17341) (FAA)

TAKEOFF MINIMUMS:

Rwy 30, std. w/ min. climb of 240' per NM to 2400 or 1400 - 3 for climb in visual conditions.

DEPARTURE PROCEDURE:

Rwy 12, climb on heading 127° to 2000 before turning right.

Rwy 30, climb on heading 313° to 2400 before turning left.

VCOA:

Rwy 30, obtain ATC approval for VCOA when requesting IFR clearance. Climb in visual conditions to cross Wessington Springs airport at or above 2800 before proceeding on course.

TAKEOFF OBSTACLE NOTES:

Rwy 12, pole 10' from DER, 10' right of centerline, 2' AGL/1531' MSL.

Fence beginning 127' from DER, 493' right of centerline, up to 9' AGL/1539' MSL.

Tree 1753' from DER, 759' right of centerline, 50' AGL/1575' MSL.

Pole 2003' from DER, 1030' right of centerline, 57' AGL/1580' MSL.

Rwy 30, pole 10' from DER, 9' left of centerline, 1546' MSL.

Fence 12' from DER, 498' left of centerline, 9' AGL/1554' MSL.

Tree 812' from DER, 332' right of centerline, 1565' MSL.

Pole 4998' from DER, 320' left of centerline, 73' AGL/1672' MSL.

Tree 1.2 NM from DER, 1336' left of centerline, 1731' MSL.

Trees beginning 1.3 NM from DER, 2293' left of centerline, up to 1771' MSL.

Trees beginning 1.4 NM from DER, 2587' left of centerline, up to 1794' MSL.

Tree 1.6 NM from DER, 2761' left of centerline, up to 1805' MSL.

Tree 1.8 NM from DER, 3351' left of centerline, 1845' MSL.

Tree, terrain beginning 1.9 NM from DER, 3408' left of centerline, up to 1887' MSL.

Tree beginning 2 NM from DER, 3138' left of centerline, up to 1890' MSL.

Tree and pole beginning 2.1 NM from DER, 2642' left of centerline, up to 40' AGL/1926' MSL.

Trees beginning 2.2 NM from DER, 1876' left of centerline, up to 100' AGL/1932' MSL.

22 FEB 2024 to 21 MAR 2024

22 FEB 2024 to 21 MAR 2024

TAKEOFF MINIMUMS, (OBSTACLE) DEPARTURE PROCEDURES, AND DIVERSE VECTOR AREA (RADAR VECTORS)

24025

NC-1

TAKEOFF MINIMUMS, (OBSTACLE) DEPARTURE PROCEDURES, AND DIVERSE VECTOR AREA (RADAR VECTORS)

24025

WHEATON, MN

WHEATON MUNI (ETH)

TAKEOFF MINIMUMS AND (OBSTACLE) DEPARTURE PROCEDURES

AMDT 2 08NOV18 (18312) (FAA)

TAKEOFF MINIMUMS:

Rwys 6, 24, NA – ATC.

TAKEOFF OBSTACLE NOTES:

Rwy 16, electrical pole beginning 9' from DER, 16' right of centerline, up to 1024' MSL.

Tree 87' from DER, 136' right of centerline, up to 1025' MSL.

Tree 110' from DER, 155' left of centerline, up to 1026' MSL.

Tree 178' from DER, 480' left of centerline, up to 49' AGL/1072' MSL.

Tree 252' from DER, 478' left of centerline, up to 55' AGL/1078' MSL.

Tree 487' from DER, 616' right of centerline, up to 79' AGL/1102' MSL.

Tree, pole beginning 384' from DER, 22' left of centerline, up to 93' AGL/1116' MSL.

Tree, pole, building beginning 540' from DER, 3' right of centerline, up to 102' AGL/1125' MSL.

Trees beginning 2209' from DER, 339' right of centerline, up to 109' AGL/1132' MSL.

Trees beginning 2344' from DER, 342' right of centerline, up to 114' AGL/1137' MSL.

Trees beginning 2418' from DER, 499' right of centerline, up to 115' AGL/1138' MSL.

Trees beginning 2531' from DER, 133' right of centerline, up to 116' AGL/1139' MSL.

Tree 2882' from DER, 728' right of centerline, up to 121' AGL/1144' MSL.

Trees beginning 2901' from DER, 2' right of centerline, up to 125' AGL/1148' MSL.

Trees beginning 3499' from DER, 103' left of centerline, up to 103' AGL/1126' MSL.

Tree 3571' from DER, 80' left of centerline, up to 105' AGL/1128' MSL.

Tree 3664' from DER, 35' left of centerline, up to 108' AGL/1131' MSL.

Trees beginning 3700' from DER, 26' left of centerline, up to 110' AGL/1133' MSL.

Trees beginning 4490' from DER, 67' left of centerline, up to 120' AGL/1143' MSL.

Rwy 34, building 1' from DER, 453' right of centerline, up to 18' AGL/1035' MSL.

Electrical pole beginning 8' from DER, 16' left of centerline, up to 1018' MSL.

Tree, sign beginning 96' from DER, 361' right of centerline, up to 23' AGL/1040' MSL.

Building beginning 236' from DER, 515' right of centerline, up to 29' AGL/1044' MSL.

Tree 870' from DER, 683' right of centerline, up to 31' AGL/1046' MSL.

Tree 964' from DER, 515' right of centerline, up to 63' AGL/1078' MSL.

WILLISTON, ND

WILLISTON BASIN INTL (XWA)

TAKEOFF MINIMUMS AND (OBSTACLE) DEPARTURE PROCEDURES

AMDT 1 17JUN21 (21168) (FAA)

TAKEOFF OBSTACLE NOTES:

Rwy 32, vehicles on road beginning 6' from DER, 372' right of centerline, up to 2317' MSL.

Pole, vehicles on road beginning 101' from DER, 206' right of centerline, up to 65' AGL/2368' MSL.

WILLMAR, MN

WILLMAR MUNI/JOHN L RICE FLD (BDH)

TAKEOFF MINIMUMS AND (OBSTACLE) DEPARTURE PROCEDURES

ORIG-A 06DEC18 (22027) (FAA)

TAKEOFF MINIMUMS:

Rwys 3, 21, NA-Environmental.

TAKEOFF OBSTACLE NOTES:

Rwy 31, tree 1338' from DER, 740' left of centerline, 67' AGL/1193' MSL.

WINDOM, MN

WINDOM MUNI (MWM)

TAKEOFF MINIMUMS AND (OBSTACLE) DEPARTURE PROCEDURES

ORIG 18NOV10 (10322) (FAA)

TAKEOFF MINIMUMS:

Rwy 35, 200-1½ or std. w/ min. climb of 225' per NM to 1700, or alternatively, with std. takeoff minimums and a normal 200' per NM climb gradient, takeoff must occur no later than 1700' prior to DER.

TAKEOFF OBSTACLE NOTES:

Rwy 17, trees beginning 1074' from DER, 461' right of centerline, up to 100' AGL/1409' MSL.

Rwy 35, trees beginning 1.1 NM from DER, 2057' right of centerline, up to 100' AGL/1599' MSL.

WINNER, SD

WINNER RGNL (ICR)

TAKEOFF MINIMUMS AND (OBSTACLE) DEPARTURE PROCEDURES

AMDT 4 21JUL16 (16203) (FAA)

TAKEOFF MINIMUMS:

Rwy 3, 21, NA-Environmental.

TAKEOFF MINIMUMS, (OBSTACLE) DEPARTURE PROCEDURES, AND DIVERSE VECTOR AREA (RADAR VECTORS)

24025

TAKEOFF MINIMUMS, (OBSTACLE) DEPARTURE PROCEDURES, AND DIVERSE VECTOR AREA (RADAR VECTORS)

24025

WINONA, MN

WINONA MUNI-MAX CONRAD FIELD (ONA)

TAKEOFF MINIMUMS AND (OBSTACLE) DEPARTURE PROCEDURES

AMDT 5A 22JUN17 (17173) (FAA)

TAKEOFF MINIMUMS:

Rwy 30, 700-2¾ w/min. climb of 318' per NM to 1700 or std. w/min. climb of 454' per NM to 1300 or 1400-2¾ for VCOA.

DEPARTURE PROCEDURE:

Rwy 12, climb heading 110° to 1900 before turning.

Rwy 30, climb heading 300° to 1400 before turning.

VCOA:

Rwy 30, obtain ATC approval for VCOA when requesting IFR clearance. Climb in visual conditions to cross Winona Muni-Max Conrad Field at or above 1900 before proceeding on course.

TAKEOFF OBSTACLE NOTES:

Rwy 12, fence beginning 89' from DER, 102' right of centerline, 5' AGL/660' MSL.

Trees beginning 958' from DER, left and right of centerline, up to 87' AGL/737' MSL.

Rwy 30, trees beginning 789' from DER, 28' right of centerline, 104' AGL/758' MSL.

Tree 56' from DER, 431' left of centerline, 12' AGL/666' MSL.

WORTHINGTON, MN

WORTHINGTON MUNI (OTG)

TAKEOFF MINIMUMS AND (OBSTACLE) DEPARTURE PROCEDURES

AMDT 4 27JAN22 (22027) (FAA)

TAKEOFF MINIMUMS:

Rwy 18, 300-1¼ or std. w/min. climb of 240' per NM to 1900.

TAKEOFF OBSTACLE NOTES:

Rwy 18, general utility pole 34' from DER, 78' left of centerline, 5' AGL/1577' MSL.

General utility pole 34' from DER, 77' right of centerline, 4' AGL/1577' MSL.

Pole 454' from DER, 529' right of centerline, 25' AGL/1598' MSL.

Pole 517' from DER, 616' right of centerline, 36' AGL/1609' MSL.

Pole 593' from DER, 536' right of centerline, 37' AGL/1610' MSL.

Building 702' from DER, 626' right of centerline, 37' AGL/1611' MSL.

NAVAID 1200' from DER, 432' left of centerline, 36' AGL/1606' MSL.

Pole 4280' from DER, 1613' right of centerline, 106' AGL/1682' MSL.

Rwy 29, terrain 17' from DER, 2' right of centerline, 1574' MSL.

Vehicles beginning 105' from DER, 257' left of centerline, up to 1587' MSL.

Trees beginning 1082' from DER, 474' left of centerline, up to 1625' MSL.

YANKTON, SD

CHAN GURNEY MUNI (YKN)

TAKEOFF MINIMUMS AND (OBSTACLE) DEPARTURE PROCEDURES

AMDT 3 17JUN21 (21168) (FAA)

DEPARTURE PROCEDURE:

Rwy 2, climb on heading 018° to 1900 before turning east.

Rwy 13, climb on heading 137° to 2100 before turning east.

TAKEOFF OBSTACLE NOTES:

Rwy 2, trees beginning 21' from DER, 50' right of centerline, up to 100' AGL/1400' MSL.

Trees beginning 59' from DER, 35' left of centerline, up to 100' AGL/1416' MSL.

Trees beginning 869' from DER, 7' right of centerline, up to 100' AGL/1403' MSL.

Trees beginning 4827' from DER, 368' left of centerline, up to 100' AGL/1419' MSL.

Rwy 13, pole 325' from DER, 524' right of centerline, 11' AGL/1281' MSL.

Rwy 20, tree 78' from DER, 72' right of centerline, 100' AGL/1367' MSL.

Trees beginning 160' from DER, 29' right of centerline, up to 100' AGL/1370' MSL.

Trees beginning 198' from DER, 246' left of centerline, up to 100' AGL/1350' MSL.

Trees beginning 361' from DER, 39' left of centerline, up to 100' AGL/1354' MSL.

Trees beginning 2792' from DER, 319' right of centerline, up to 100' AGL/1373' MSL.

Trees beginning 3439' from DER, 624' right of centerline, up to 100' AGL/1377' MSL.

Rwy 31, tree 474' from DER, 421' right of centerline, 1319' MSL.

Tree 635' from DER, 228' right of centerline, 1324' MSL.

Trees beginning 846' from DER, 555' left of centerline, up to 1358' MSL.

22 FEB 2024 to 21 MAR 2024

22 FEB 2024 to 21 MAR 2024

TAKEOFF MINIMUMS, (OBSTACLE) DEPARTURE PROCEDURES, AND DIVERSE VECTOR AREA (RADAR VECTORS)

24025

NC-1